

EWF7524D3WB  
EWF8024D3WB  
EWF9024D3WB



<b>EN</b>	Washing Machine	User Manual	2
<b>MS</b>	Mesin Basuh	Manual Pengguna	38
<b>ZH</b>	洗衣机	用户手册	74

## Enjoy peace of mind. Register your appliance today.

Stay updated on better living services,  
safety notices and shop for accessories.

- 1. Open the camera app on your smartphone and point at the QR code to scan.**

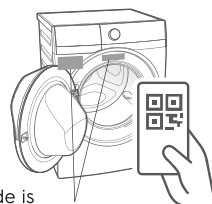

Product Registration QR code is located on the front of your appliance or inside the door rim.

- 2. Tap the notification or link to open the registration form.**
- 3. Complete your details and enjoy peace of mind.**



**Electrolux**

## IMPORTANT INFORMATION THAT MAY IMPACT YOUR MANUFACTURER’S WARRANTY

Adherence to the directions for use in this manual is extremely important for health and safety. Failure to strictly adhere to the requirements in this manual may result in personal injury, property damage and affect your ability to make a claim under the Electrolux manufacturer’s warranty provided with your product. Products must be used, installed and operated in accordance with this manual. You may not be able to claim on the Electrolux manufacturer’s warranty in the event that your product fault is due to failure to adhere to this manual.

## WE’RE THINKING OF YOU

Thank you for purchasing an Electrolux appliance. You’ve chosen a product that brings with it decades of professional experience and innovation. Ingenious and stylish, it has been designed with you in mind. So whenever you use it, you can be safe in the knowledge that you’ll get great results every time. Welcome to Electrolux.



**Visit our website to:**



Get usage advice, brochures, trouble shooting, service information, buy accessories & spare parts, online product registration : **www.electrolux.com**

## CUSTOMER CARE AND SERVICE

We recommend the use of original spare parts. When contacting Service, ensure that you have the following data available. The information can be found on the rating plate. Model, PNC, Serial Number.

-  Warning / Caution-Safety information.
-  General information and tips.
-  Environmental information.

Subject to change without notice.

## CONTENTS

<b>1. SAFETY INFORMATION</b>	
1.1 Conditions Of Use .....	4
1.2 Child Safety.....	5
1.3 General Safety .....	6
1.4 Installation .....	6
1.5 Use .....	7
<b>2. PRODUCT DESCRIPTION</b>	
2.1 Parts .....	8
2.2 Accessories .....	9
<b>3. CONTROL PANEL</b>	
3.1 Control Panel Description .....	10
3.2 Program Chart .....	11
3.3 Program Options Compatibility.....	12
3.4 Options .....	13
3.5 Settings .....	15
3.6 Start/Pause ( >   ) and Add Clothes ( 𐀀 ) Touchpad .....	16

<b>4. BEFORE FIRST USE</b> .....	16
<b>5. DAILY USE</b>	
5.1 Loading The Laundry.....	17
5.2 Using Detergent And Additives .....	17
5.3 Options Setting .....	18
5.4 Starting A Cycle (▷  ).....	19
5.5 Interruption Of A Program .....	19
5.6 Changing A Program .....	19
5.7 Changing The Options .....	19
5.8 Opening The Door.....	19
5.9 At The End Of The Program .....	19
5.10 When The Washing Program Is Completed, But There Is Water In The Drum .....	20
5.11 AUTO Off Mode .....	20
<b>6. WASHING HINTS</b>	
6.1 Sorting The Laundry .....	21
6.2 Temperatures.....	21
6.3 Before Loading The Laundry.....	21
6.4 Maximum Loads.....	21
6.5 Removing Stains .....	21
6.6 Detergents Type And Quantity Of Detergent .....	22
<b>7. INTERNATIONAL WASH CODE SYMBOLS</b> .....	23
<b>8. CARE AND CLEANING</b>	
8.1 External Cleaning .....	24
8.2 Descaling .....	24
8.3 After Each Wash .....	24
8.4 Maintenance Wash With “Tub Clean” Program .....	24
8.5 Cleaning The Dispenser Drawer .....	24
8.6 Cleaning The Drawer Recess .....	25
8.7 Cleaning The Water Inlet Filter .....	25
8.8 Frost Precautions .....	26
<b>9. TROUBLESHOOTING</b>	
9.1 Possible Failures .....	27
9.2 Emergency Door Opening .....	30
<b>10. TECHNICAL DATA</b> .....	31
<b>11. INSTALLATION</b>	
11.1 Unpacking.....	31
11.2 Positioning.....	33
11.3 Water Inlet.....	34
11.4 Water Drainage .....	34
11.5 Electrical Connection .....	36
<b>12. ENVIRONMENT CONCERNS</b>	
12.1 Packaging Materials .....	37
12.2 Old Machine .....	37
12.3 Ecological Hints .....	37

# 1. SAFETY INFORMATION

## 1.1 Conditions Of Use

This appliance is intended to be used in household and similar applications such as:

- staff kitchen areas in shops, offices and other working environment;
- farm houses;
- by clients in hotels, motels, and other residential type environments;
- bed and breakfast type environments;
- areas for communal use in blocks of flats or in launderettes.

 **WARNING!** The appliance must not be supplied through an external switching device, such as timer, or connected to a circuit that is regularly switched on and off by utility.

In the interest of your safety and to ensure the correct use, before installing and first using the appliance, read this user manual carefully, including its hints and warnings.

To avoid unnecessary mistakes and accidents, it is important to ensure that all people using the appliance are thoroughly familiar with its operation and safety features.

Save these instructions and make sure that they remain with the appliance if it is moved or sold, so that everyone using it through its life will be properly informed on appliance use and safety.

## 1.2 Child Safety

- This washing machine is not intended for use by young children or infirm persons without supervision.
- Young children should be supervised to ensure that they do not play with the appliance.
- The packaging components (e.g. plastic film, polystyrene) can be dangerous to children - danger of suffocation! Keep them out of children's reach.
- Keep all detergents in a safe place out of children's reach.
- Make sure that children or pets do not climb into the drum.
- This machine is provided with child safety lock option () to prevent children playing with the control panel. (see page 15)

### 1.3 General Safety

- It is dangerous to alter the specifications or attempt to modify this product in any way.
- During high temperature wash program the door glass may get hot. Do not touch it!
- Make sure that small pets do not climb into the drum. To avoid this, please check inside the drum before using the appliance.
- Any objects such as coins, safety pins, nails, screws, stones or any other hard, sharp material can cause extensive damage and must not be placed into the machine.
- Wash small items such as socks, laces, washable belts etc in a washing bag or pillow case as it is possible for such items to slip down between the tub and the inner drum.
- Only use manufacturer's recommended quantities of fabric softener and detergent. Damage to the fabric or appliance can occur if you exceed the recommended amount.
- Do not use your washing machine to wash articles with whalebones, material without hems or torn material.
- Always unplug the appliance and turn off the water supply after use, clean and maintenance.
- This appliance is not intended for use by persons (including children) with reduced physical, sensory or mental capabilities, or lack of experience and knowledge, unless they have been given supervision or instruction concerning use of the appliance by a person responsible for their safety.
- Under no circumstances should you attempt to repair the machine yourself. Repairs carried out by inexperienced persons may cause injury or serious malfunctioning. Contact your local Service Centre. Always insist on genuine spare parts.

### 1.4 Installation

- This appliance is heavy. Care should be taken when moving it.
- When unpacking the appliance, check that it is not damaged. If in doubt, do not use it and contact the Service Centre.
- All packing and transit bolts must be removed before use. Serious damage can occur to the product and to property if this is not adhered to. See relevant section in the user manual.
- After having installed the appliance, check that it is not standing on the inlet and drain hose and the worktop is not pressing the electrical supply cable.
- If the appliance is installed on a carpeted floor, please adjust the feet in order to allow air to circulate freely.
- Always be sure, that there is no water leakage from hoses and their connections after the installation.
- Any plumbing work required to install this appliance should be carried out by a qualified plumber.
- Any electrical work required to install this appliance should be carried out by a qualified electrician.



**May cause electric shock! if the machine is not connected to an earthed/ground system. DO NOT touch the wet clothes and metal parts.**



**For safety reasons do not use double adapters, extension cords and multi-plug adapters.**

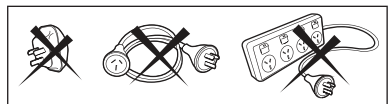

## 1.5 Use

- Only wash fabrics which are designed to be machine washed. Follow the instructions on each garment label.
  - Do not overload the appliance. See the relevant section in the user manual.
  - Before washing, ensure that all pockets are empty and buttons and zips are fastened. Avoid washing frayed or torn articles and treat stains such as paint, ink, rust, and grass before washing.
  - Garments which have been in contact with volatile petroleum products should not be machine washed. If volatile cleaning fluids are used, care should be taken to ensure that the fluid is removed from the garment before placing in the machine.
  - Never pull the power supply cable to remove the plug from the socket; always take hold of the plug itself.
  - Never use the washing machine if the power supply cable, the control panel, the working surface or the base are damaged so that the inside of the washing machine is accessible.
-

## 2. PRODUCT DESCRIPTION

### 2.1 Parts

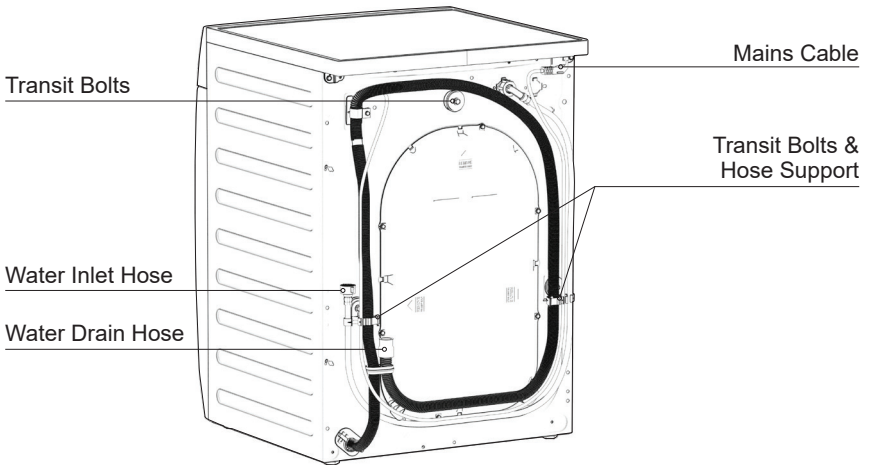
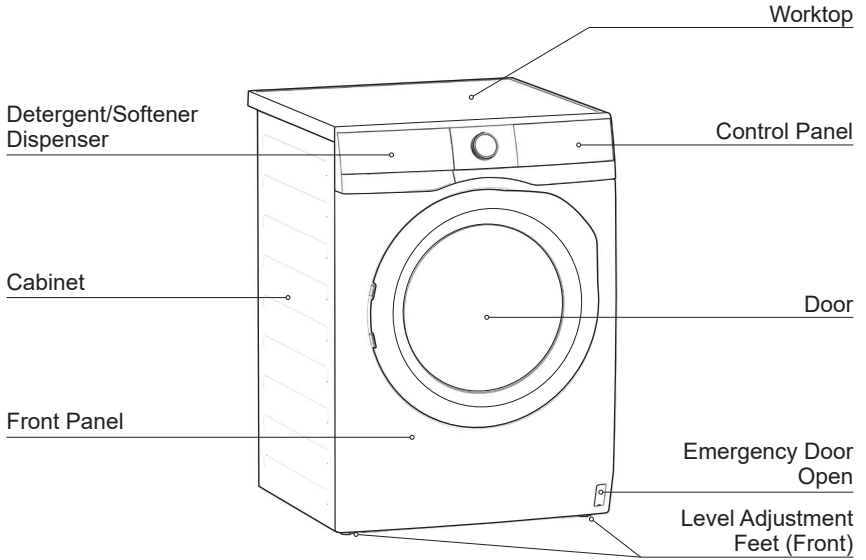



**Detergent/Softener Dispenser**  
(For more informations, see page 17, 24)

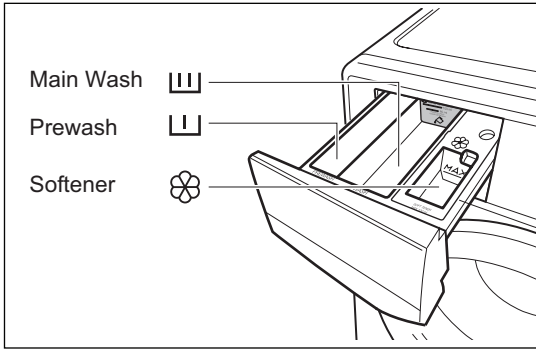

**Door (when open)**  
(for more informations, see page 17)

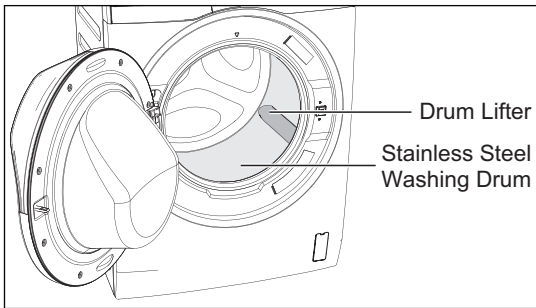

**Emergency Door Opening**

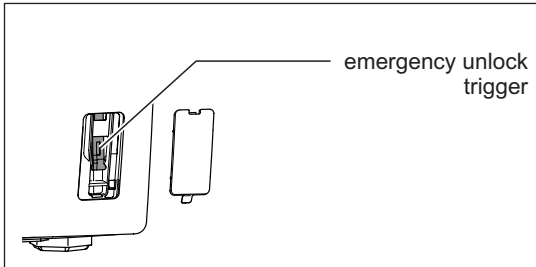

**Level Adjustment Feet**

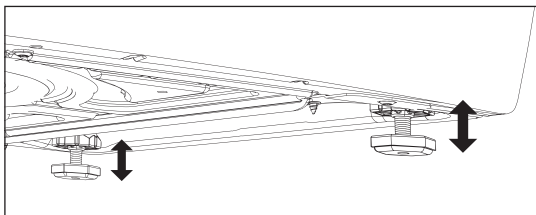

**Transit Bolt (when remove)**

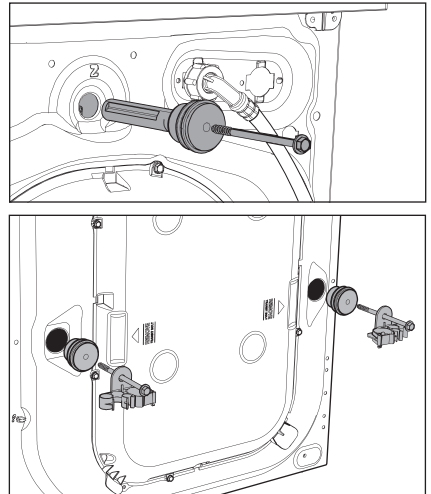

**Transit bolts must be removed before using the appliance.**

**2.2 Accessories**

**Plastic Caps**

To close the holes on the rear side of the cabinet after the removal of the transit bolts.



**Plastic Hose Guide**

To connect the drain hose on the edge of a sink.

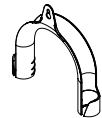

## 3. CONTROL PANEL

### 3.1 Control Panel Description

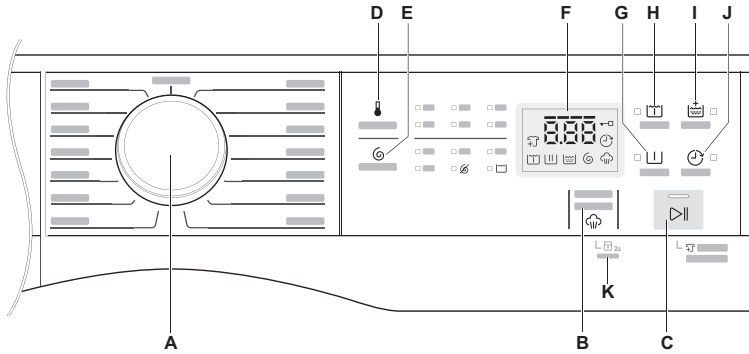

**A** Program knob

**B** Hygienic Care touchpad

**C** Start/Pause touchpad

**D** Temp touchpad

**E** Spin touchpad

**F** Display

**G** Prewash touchpad

**H** Soak touchpad

**I** Extra Rinse touchpad

**J** Delay End touchpad

**K** Child Lock Option

#### Display

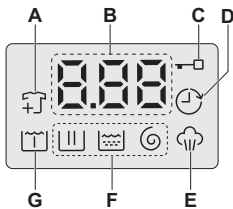

**A** Add Clothes Icon

**B** Program Duration / Delay End Time / Alarm Code

**C** Door Lock Icon

**D** Delay End Icon

**E** Vapour phase Icon

**F** Program Phase Indication Icon:  
 [Wash Cycle Icon] Wash Phase, [Rinse Cycle Icon] Rinse Phase,  
 [Spin Cycle Icon] Spin Phase

**G** Soak Phase Icon

### 3.2 Program Chart







Program; Temperature range	Max. Spin Speed	Max. Load (Dry Clothes)	Type of load and soil level
<b>Off</b>	-	-	This position to reset program/switching off the machine.
<b>Cottons;</b> Cold to 90°C	1200 rpm	<b>Max. 1)</b>	White and coloured cotton.
<b>Mixed;</b> Cold to 60°C	1200 rpm	4 kg	Synthetic or mixed fabric items.
<b>Delicates;</b> Cold to 40°C	1200 rpm	4 kg	Delicate fabrics such as acrylics, viscose, polyester items.
<b>Bedding;</b> Cold to 40°C	800 rpm	3 kg	Special program for one synthetic blanket, duvet, bedspread and so on.
<b>Energy Saver;</b> 40°C and 60°C <sup>2)</sup>	1200 rpm	<b>Max. 1)</b>	White and colourfast cotton. Set this program to have a good washing results and decrease the energy consumption. The time of the washing program is extended.
<b>Tub Clean;</b> 60°C	-	-	For cleaning the tub.
<b>Spin</b>	1200 rpm	<b>Max. 1)</b>	To spin the laundry and drain the water in the drum.
<b>Rinse + Spin</b>	1200 rpm	<b>Max. 1)</b>	To rinse and spin the laundry.
<b>Baby Care;</b> Cold to 40°C	1200 rpm	4 kg	Baby cotton clothes and delicate knitting items with normal soil.
<b>Quick 15;</b> Cold to 30°C	1200 rpm	1.5 kg	Lightly soiled synthetics or mixed fabrics.
<b>Daily 39;</b> 30°C to 40°C	1200 rpm	EWF7524D3WB EWF8024D3WB <u>4 kg</u> EWF9024D3WB 5 kg	Daily wear coloured cotton clothes such as shirts, blouses, towels and undergarments. Ideal for low level of soil.

Program; Temperature range	Max. Spin Speed	Max. Load (Dry Clothes)	Type of load and soil level
Full Wash 60; 30°C to 60°C	1200 rpm	Max. <sup>1)</sup>	Daily wear coloured cotton clothes such as shirts, blouses, towels and undergarments. Ideal for normal level of soil.

1) Maximum capacity depended on the model of the Washing Machine (see defined on the control panel)

2) Energy Saver Program with 60degC option selected is recommended for a full load of normally soiled cotton and is the Energy and Water rating label program.

### 3.3 Program Options Compatibility

Program	Option						
	 No Spin	 Rinse Hold	 Soak	 Extra Rinse	 Prewash	 Delay End	 Hygienic Care <sup>1)</sup>
Cottons	■	■	■	■	■	■	■
Mixed	■	■	■	■	■	■	■
Delicates	■	■	■	■	■	■	■
Bedding	■	■	■	■	■	■	■
Energy Saver	■	■	■	■	■	■	■
Tub Clean							
Spin	■						■
Rinse + Spin	■	■					■
Baby Care	■	■		■	■	■	■
Quick 15	■	■					■
Daily 39	■						■
Full Wash 60	■	■		■			■

1) “Hygienic Care” option can be combined with temperature 40 to 90 °C only.

### 3.4 Options

#### Temperature Touchpad

Press this touchpad repeatedly to increase or decrease the wash temperature if you want your laundry to be washed at a temperature different from the one proposed by the washing machine. (Symbol “✱” corresponds to cold wash)

#### Spin Selection Touchpad

Press this touchpad repeatedly to increase or decrease the spin speed or select Rinse Hold, if you want your laundry to be spun at a speed different from the one proposed by the washing machine.



- **No Spin** (  )

No spin option eliminates all the spin phases and increase the number of rinses.

- **Rinse Hold** (  )

By selecting this option the water of the last rinse is not emptied out and the drum turns regularly to prevent the laundry creases.



The door is still locked to indicate that the water must be emptied out.

 The door stays locked with the water in the drum. To continue the cycle, you must press  (Start/Pause).

#### Soak

This option allows you to soak heavily soiled clothes and stained items at the beginning of the wash before main washing phase.

This option will increase the duration of the program selected for about 50 minutes. And uses more water from normal wash. The process is as follows.

 Add detergent for “Soak” at the “Prewash  ” compartment.

1. Fill water and turn the washing drum (this takes about 20 minutes).

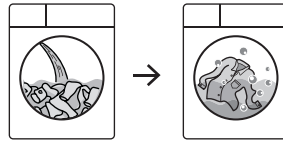

After press the Start/Pause touchpad, the machine will start to add water to the washing drum, which will start to rotate slowly to dissolve detergent and evenly distribute clothes.

2. Soak (this takes about 30 minutes).

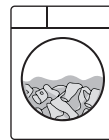

The machine will enter the process of soaking. The washing drum will stop and rotate once in a while in order to distribute clothes.

3. Once the soaking process complete, the machine will check the water level again and will start the selected program and continue by using the same soak water.

#### NOTE

If you do not wish to use the soak water to wash cloth, please follow the steps below:

1. Press Start/Pause to pause the washing machine. Then rotate the program knob to “Off” to turn off the machine.
2. Add detergent to the main wash compartment and select the program of your choice. Press Start/Pause again to start the selected program.

The machine will detect and drain the water in the washing drum out automatically and fill in water once again to be used for washing.

### **i** NOTE

- Any temperature may be selected, but “Cold” water is recommended with this cycle as hotter water may set some stains.
- Use the amount of detergent recommended for a normal wash cycle. If desired, use a bleach or a soaking agent safe for the fabric, by pouring it into the detergent compartment.

## Extra Rinse Touchpad

This option is recommended for people who are allergic to detergents, and in areas where the water is very soft.

Press this touchpad to add two rinse phases to a program. The indicator of this option will be on.

## Prewash ( ) Touchpad

Select this option if you wish your laundry to be pre-washed before the main wash. Use this option for heavy soil. The indicator of this option will be on.

When you set this function, put the detergent into the “  ” compartment.

This function increases the program duration.

## Delay End ( ) Touchpad

Before you start the program, this option makes it possible to define the end of the washing program from minimum of 1 hour to maximum of 20 hours.

**i** If program duration is longer than 3 hours, minimum Delay End option starts from 4 hours.

Press the Delay End touchpad to choose the end time as you wish. The display shows the number of hours and the indicator beside the touchpad is on.

**i** This option must be selected after choosing the wash program, and before pressing the “Start/Pause” touchpad.

For example, if the program duration of your selected program is 3.20 hours and you define the “Delay End” time to 6 hours. This means your wash program will finish in 6 hours. (See diagram)

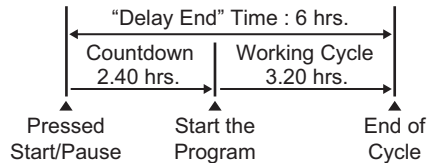

After selecting Delay End time, press Start/Pause touchpad to start the program. Machine will then countdown and update time on the display every hours until it reaches the starting point of the wash cycle.

If you wish to modify or cancel Delay End option after starting the program, follow the steps below:

- set the washing machine to PAUSE by pressing “Start/Pause” touchpad;
- deselect this option by pressing “Delay End” touchpad repeatedly till the display shows delay time “  ”;
- press the “Start/Pause” to start the program.

## Hygienic Care ( ) Touchpad

Select this option to add approximately 30 minutes of tumbling in vapour after the rinse cycle. The indicator of this option will be on.

- Vapour may not necessarily be visible inside the drum during a vapour cycle. Vapour is created below the drum and allowed to naturally rise into the clothes.
- Vapour may not be present during the entire vapour cycle.
- Vapour function is more effective with half load.

- At the end of the Vapour cycle, the clothes will be warmer, softer and detached from the drum.

### NOTE

If Vapour option is selected, rinse temperatures will be elevated.

During a vapour cycle, you may notice vapour exiting from the drain hose of the washing machine, this is normal and there is no cause for alarm.

## 3.5 Settings



### Child Safety Lock ( ) Option

Your appliance is provided with CHILD SAFETY LOCK which permits you to leave the appliance unsupervised with the door closed without having to worry that children might be injured by or cause damage to the appliance.

 Set this option after pressing the Start/Pause touchpad.

#### To set “Child Lock” option:

- To activate the function, press and hold “Hygienic Care” touchpad about 2 seconds until the display shows the icon “  ”.

 If you press any touchpad while Child Lock is activated, the icon “  ” will flash on display 3 times along with buzzer sound.



 This function remains enabled even after the appliance is switched off.

- To deactivate the function, press and hold “Hygienic Care” touchpad about 2 seconds until the display shows the icon “  ”.

### Enabling/Disabling End-Of-Wash Buzzer

This setting permits you to either enable or disable the buzzer at the end of the program. As an example, you might wish to disable this buzzer when you start a wash when going to bed, so that when the wash finished approximately 1 hour later, it will not disturb you through the night.

 Error warning beeps such as critical faults are not disabled.

- To disable the buzzer sound, press “Temp” and “Spin” touchpads at the same time about 3 seconds, the icon “  ” will show on display along with buzzer sound.
- To return to default configuration press these 2 touchpads at the same time about 3 seconds, the icon “  ” will show on display along with buzzer sound.

### 3.6 Start/Pause ( ▷|| ) and Add Clothes ( ⇄ ) Touchpad

This touchpad has 2 functions:

#### 1. Start/Pause ( ▷|| )

After you have selected the desired program and options, press this touchpad to start the machine. The Start/Pause pilot light will stop flashing and remain lit until the water level is above the bottom edge of the door then pilot light goes OFF. If you have selected a "Delay End" option, the countdown will begin and will be shown on the display.

To interrupt a program which is running, press this touchpad to pause the machine, the Start/Pause pilot light flashes.

To restart the program from the point at which it was interrupted, press this touchpad again, the Start/Pause pilot light will stop flashing.

#### 2. Add Clothes ( ⇄ )

**i** You can only add clothes when the icon " ⇄ " shown on the display.

To add clothes:

1. Pressing the "Start/Pause" touchpad to pause the program.
2. Wait for the machine to come to a complete stop before opening the door (wait for door lock " -□ " icon to turn off).
3. Add clothing and close the door.
4. Resume the program by pressing "Start/Pause" touchpad again.

---

## 4. BEFORE FIRST USE

### **i** NOTE

**During installation or before first use you may observe some water in the machine. This is a residual water left in the machine after a full functional test in the factory to ensure the machine is delivered to customers in perfect working order and is no cause for concern.**

1. Ensure that the electrical and water connections comply with the installation instructions.
2. Put 2 litres of water in the detergent compartment for washing phase. This activates the drain system.

3. Select a Cottons cycle at 90 °C, without any laundry in the machine, to remove any manufacturing residue from the drum and tub then start the machine.

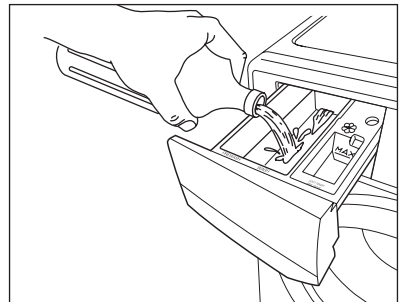



## 5. DAILY USE

### 5.1 Loading The Laundry

1. Turn the water tap on.
2. Connect the main plug to the main socket.
3. Turn the knob to set a program. The washing machine will propose a temperature and automatically select the spin value provided for the program you have chosen.

The selector knob can be turned either clockwise or anticlockwise.

Position "Off" to reset program/ switching OFF the machine.

At the end of the program the selector dial must be turned to position "Off", to switch the machine off.

4. Check and remove objects (if there are any) that could be trapped in the fold.

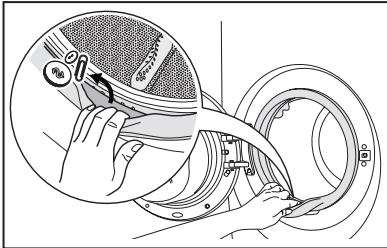

5. Place the laundry in the drum, one item at a time, shaking them out as much as possible. (Refer to page 21 "WASHING HINTS")
6. Close the door.



Make sure that no laundry remains between the seal and the door.

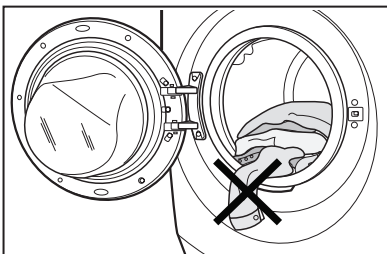

### 5.2 Using Detergent And Additives



Please read "Detergents Type and Quantity of Detergent" on page 22 before use.

1. Detergent Dispenser Drawer  
The detergent dispenser is divided into three compartments.

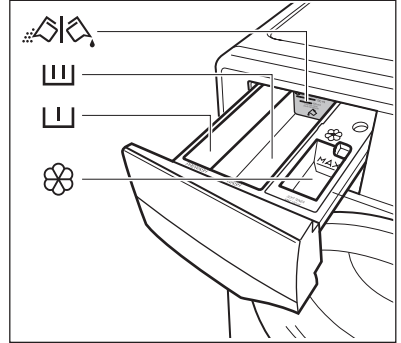

- Compartment "PREWASH"  
This compartment is only used for detergent when a "Prewash" option is selected.
- Compartment "MAIN WASH"  
This compartment is used for detergent on all programs.



Detergent flap

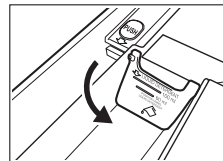

**Position down:**  
for liquid detergent.

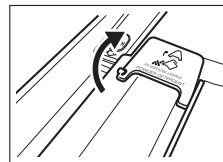



**Position up:** for powder detergent.

- Compartment "SOFTENER"  
This compartment is used for fabric conditioner and starching agent.

**i NOTE: When you use the liquid detergent**

- Do not use gelatinous or thick liquid detergents.
- Do not put more liquid than the maximum level.
- Do not set the "Prewash" phase.
- Do not set the "Delay End".

2. Measure out the detergent and the fabric softener;

- Pull out the dispenser drawer until it stops.
- Measure out the amount of detergent required, pour it into the main wash compartment .
- If you wish to carry out the "Prewash" phase, pour it into the compartment marked .

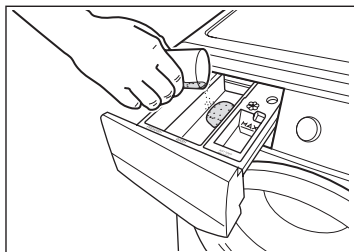

- If required, pour fabric softener into the compartment marked .

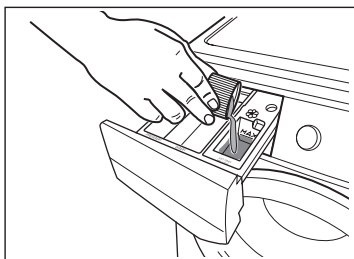

**i NOTE**

The softener amount used must not exceed the "MAX" mark in the drawer.

If you use thick softeners it is recommended to dilute with water.

- Close the drawer gently.

**i NOTE**

Residues of detergent, softener and water may remain in the dispenser. It is recommended to clean the dispenser regularly to remove any residue.

### 5.3 Options Setting

1. If you want your laundry to be spun or use temperature different from the one proposed by the washing machine, press "Spin" and "Temp" touchpads repeatedly to change the spin speed and temperature.

Press the option touchpads, if you want your laundry to be washed with special functions.

**i NOTE**

- Different functions can be combined which is dependent on the program selected.
- If an option is not compatible with the wash program selected, the symbol " - - - " will flash on display along with buzzer sound.

2. If you want to define the end of the washing program, press the "Delay End" touchpad repeatedly to choose your washing machine working time.

## 5.4 Starting A Cycle ( ▷|| )

To start a program, press the Start/Pause touchpad. The corresponding pilot light will stop flashing and a default program duration will be displayed on the screen.

After approx. 15 minutes from the start of a program:

- The appliance will automatically adjust the selected program duration according to the type and size of the load.
- The display will show adjusted program duration.

### NOTE

If you press any touchpad while a program is operating, the symbol “- - -” will flash on display along with buzzer sound.

## 5.5 Interruption Of A Program

- To pause, press Start/ Pause. The indicator will start flashing.
- Press the Start/Pause again. The program will continue.

## 5.6 Changing A Program

Changing a running program is possible only by resetting it.

- Turn the program selector knob to the position “Off” to cancel the program and to turn off the appliance.
- Turn the program selector knob to the new program position and change any available options. Press Start/Pause to start the new program.

### NOTE

The appliance will not drain the water (except programs; Spin, Rinse + Spin, Tub Clean).

## 5.7 Changing The Options

It may be possible to change some of the options after a wash program has started.

1. Press the touchpad Start/Pause. The indicator will start flashing.
2. If available change the options that you wish.
3. Press Start/Pause again. The program will continue.

## 5.8 Opening The Door



While a program or the Delay End is operating, the appliance door is locked and the display shows the indicator “”. First, set the machine to PAUSE by pressing the “Start/Pause” touchpad. Wait until the door lock indicator goes off, then the door can be opened.

If the door lock indicator “” does not disappear, this means that the machine is already heating and the water level is above the bottom edge of the door or the drum is turning. In this case the door CAN NOT be opened. If you need to open it, you must drain the water to open the door.



**In case of emergency please refer to “Emergency door opening” on page 32.**

## 5.9 At The End Of The Program

- The appliance stops automatically.
- The acoustic signal will operate.
- The display will show “”.
- The indicator of the touchpad Start/Pause goes off.
- The door lock indicator “” goes off.
- Remove the laundry from the appliance. Make sure that the drum is empty.
- Keep the door partly open, to prevent the mildew and odours.
- Turn off the water tap.

**i** NOTE

At the end of the program, the time remaining can suddenly decrease from 7 minutes or less to 0 due to the overestimated total program time during the load sensing phase. In some cases (with perfectly balanced load) the program time can be shorter than the time estimated after the load sensing phase is completed. This is a normal behavior of the machine and not a cause for concern as it does not compromise its performance.

### 5.10 When The Washing Program Is Completed, But There Is Water In The Drum (Option “Rinse Hold ” is used)

- The drum turns regularly to prevent the creases in the laundry.
- The indicator “Start/Pause” flashes to remind you to drain the water.
- The door lock indicator “  ” is on. The door stays locked.

**i** You must drain the water to open the door.**To drain the water:**

1. Press the “Start/Pause  ” touchpad. The appliance drains the water and spins with the maximum spin speed for selected program.

**Alternatively**, before pressing the “Start/Pause” touchpad, you can press the “Spin ” touchpad to change the spin speed. You can select “No Spin (  )”, if you want the machine to only drain the water.

2. When the program is completed and the door lock indicator “  ” goes off, you can open the door.
3. Turn the program selector knob to the position “Off” to turn off the appliance.

**i** NOTE

After approximately 18 hours, if you do not press Start/Pause touchpad, the appliance will drain and spin automatically.

### 5.11 AUTO Off Mode

5 minutes after the washing program ends, if you do not deactivate the appliance, the energy saving function activates.

The energy saving function decreases the energy consumption when the appliance is in the stand by mode.

- All indicators and the display will switch off.
- The indicator of the touchpad Start/Pause will flash slowly.
- Press one of the touchpads to deactivate the energy saving status.

## 6. WASHING HINTS

### 6.1 Sorting The Laundry

Follow the wash code symbols on each garment label and the manufacturer's washing instructions. Sort the laundry as follows: whites, coloureds, synthetics, delicates, woollens.

### 6.2 Temperatures

Temp	Soil level
90°C	For normally soiled white cottons and linen (e.g. teacloths, towels, tablecloths, sheets...).
60°C 50°C	For normally soiled, colourfast garments (e.g. shirts, night dresses, pajamas....) in linen, cotton or synthetic fibres and for lightly soiled white cotton (e.g. underwear).
40°C 30°C Cold	For delicate items (e.g. net curtains), mixed laundry including synthetic fibres and woollens bearing the label pure new wool, machine washable, non-shrink.

### 6.3 Before Loading The Laundry

- Make sure that no metal objects are left in the laundry (e.g. coin, hair clips, safety pins, pins).



- Button up pillowcases, close zip fasteners, hooks and poppers. Tie any belts or long tapes.

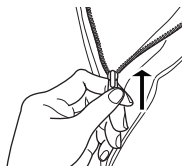

- Wash bras, pantyhose and other delicates in a mesh laundry bag, which you can purchase from your supermarket.



- Make sure that you wash lint collectors separately from lint producers.
- Never wash whites and coloured fabrics together. Whites may lose their "whiteness" in the wash.
- New coloured items may run in the first wash; they should therefore be washed separately the first time.
- Remove persistent stains before washing.
- Rub particularly soiled areas with a special detergent or detergent paste. Treat curtains with special care. Remove hooks or tie them up in a bag or a net.

### 6.4 Maximum Loads

Recommended loads are indicated in the program charts on page 11.

General rules:

Clothes Load	Quantity
Cotton, linen	drum full but not too tightly packed;
Synthetics	drum no more than half full;
Delicate fabrics and woollens	drum no more than one third full.

Washing a maximum load makes the most efficient use of water and energy. For heavily soiled laundry, reduce the load size.

### 6.5 Removing Stains

Stubborn stains may not be removed by just water and detergent. It is therefore advisable to treat them prior to washing.

**Blood:** treat fresh stains with cold water. For dried stains, soak overnight in water with a special detergent then rub in the soap and water.

**Oil based paint:** moisten with benzine stain remover, lay the garment on a soft cloth and dab the stain; treat several times.

**Dried grease stains:** moisten with turpentine, lay the garment on a soft surface and dab the stain with the fingertips and a cotton cloth.

**Rust:** oxalic acid dissolved in hot water or a rust removing product used in cold water. Be careful with rust stains which are not recent since the cellulose structure will already have been damaged and the fabric tends to hole.

**Mould stains:** treat with bleach, rinse well (whites and fast coloureds only).

**Grass:** soap lightly and treat with bleach (whites and fast coloureds only).

**Ball point pen and glue:** moisten with acetone (\*), lay the garment on a soft cloth and dab the stain.

**Lipstick:** moisten with acetone (\*) as above, then treat stains with methylated spirits. Remove any residual marks from white fabrics with bleach.

**Red wine:** soak in water and detergent, rinse and treat with acetic or citric acid, then rinse. Treat any residual marks with bleach.

**Ink:** depending on the type of ink, moisten the fabric first with acetone (\*), then with acetic acid; treat any residual marks on white fabrics with bleach and then rinse thoroughly.

**Tar stains:** first treat with stain remover, methylated spirits or benzine, then rub with detergent paste.

(\*) do not use acetone on artificial silk.

## 6.6 Detergents Type And Quantity Of Detergent

Low sudsing detergent is required for this washing machine to prevent oversudsing problems, unsatisfactory washing result and harm to the machine.

Low sudsing detergents designed for front load washing machines are labelled "Front Loading", "high efficiency", "HE", such as Cold Power for Front Loaders or "Matic".

**Do not use wrong types of detergent, such as Top Loading, Handwash detergent or Soap-Based products in your frontload washing machine. This can result in excessive suds, longer cycle time, low spin speeds, poor rinsing and overloading of the motor.**

### Quantity of detergent to be used

The choice of detergent and use of correct quantities not only affects your wash performance, but also helps to avoid waste and protect the environment. Although biodegradable detergents contain substances which in large quantities can upset the delicate balance of nature.

The choice and quantity of detergent will depend on ;

- type of fabric (delicates, woollens, cottons, etc.) ;
- the colour of clothes ;
- size of the load ;
- degree of soil ;
- wash temperature ; and
- hardness of the water used.

Water hardness is classified by so-called "degrees" of hardness.

Information on hardness of the water in your area can be obtained from the relevant water supply company, or from your local authority.

You may have to try using the detergent quantity as per manufacturers' instructions then compare the wash result to the list below and adjust the amount of detergent for your future washes accordingly.

**Not enough detergent causes:**

- the washload to turn grey,
- greasy clothes.

**Too much detergent causes:**































- sudsing,
- reduced washing effect,
- inadequate rinsing.

**Use less detergent if:**

- you are washing a small load,
- the laundry is lightly soiled,
- large amounts of foam during washing.

## 7. INTERNATIONAL WASH CODE SYMBOLS

 These symbols appear on fabric labels, in order to help you choose the best way to treat your laundry.

 <b>Energetic wash</b>	 Max. wash temperature 95 °C	 Max. wash temperature 60 °C	 Max. wash temperature 40 °C	 Max. wash temperature 30 °C	 Hand wash	 DO NOT wash at all
 <b>Delicate wash</b>			 			
 <b>Bleaching</b>	 Bleach in cold water			 DO NOT bleach		
 <b>Ironing</b>	 Hot iron max. 200 °C	 Warm iron max. 150 °C	 Lukewarm iron max. 110 °C	 DO NOT iron		
 <b>Dry cleaning</b>	 Dry cleaning in all solvents	 Dry cleaning in perchlorethylene, petrol, pure alcohol, R 111 & R 113		 Dry cleaning in petrol, pure alcohol and R 113	 DO NOT dry clean	
 <b>Drying</b>	 Flat	 On the line	 On clothes hanger	 High temperature Low temperature Tumble dry	 DO NOT tumble dry	

## 8. CARE AND CLEANING

### **WARNING!**

You must **DISCONNECT** the appliance from the electricity supply, before you can carry out any cleaning or maintenance work.

### 8.1 External Cleaning

Clean the appliance only with soap and warm water. Fully dry all the surfaces.

### **CAUTION!**

**Do not use alcohol, solvents or chemical products.**

### 8.2 Descaling

The water we use normally contains lime. It is a good idea to periodically use a water softening powder in the machine.

Do this separately from any laundry washing, and according to the softening powder manufacturer's instructions.

This will help to prevent the formation of lime deposits.

### 8.3 After Each Wash

Leave the door open for a while. This helps to prevent mould and stagnant smells forming inside the appliance.

Keeping the door open after a wash will also help to preserve the door seal.

### 8.4 Maintenance Wash With "Tub Clean" Program

With the use of low temperature washes it is possible to get a build up of residues inside the drum.

We recommend to use "Tub Clean" program to clean the drum regularly to remove any residue.

### To run a maintenance wash:

- The drum should be empty of laundry.
- Select the "Tub Clean" program.
- Press Start/Pause to start the program.

### 8.5 Cleaning The Dispenser Drawer

The washing powder and additive dispenser drawer should be cleaned regularly.

Remove the drawer by pressing the catch downwards and by pulling it out.

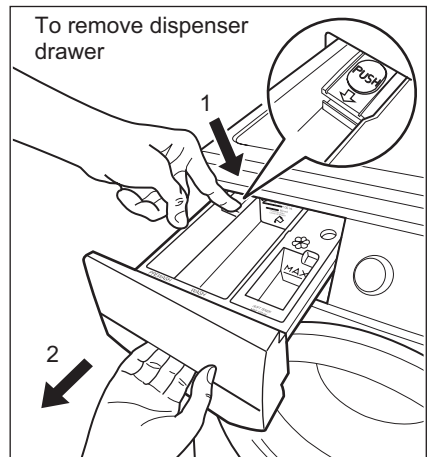

To aid cleaning, the top part of the additive compartment should be removed.

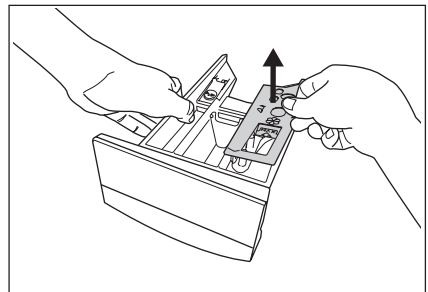



Flush it out under a tap to remove any traces of accumulated powder.

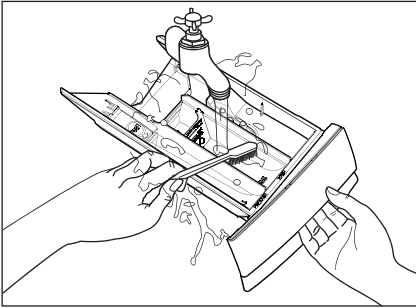

### 8.6 Cleaning The Drawer Recess

Having removed the drawer, use a small brush to clean the recess, ensuring that all washing powder residue is removed from the upper and lower part of the recess. Replace the drawer and run the rinse program without any clothes in the drum.

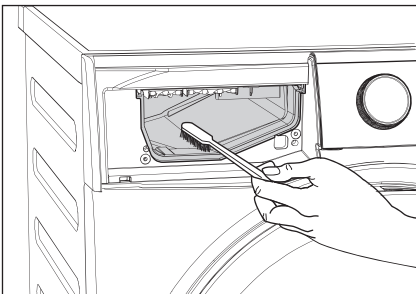

### 8.7 Cleaning The Water Inlet Filter

If your water is very hard or contains traces of lime deposit, the water inlet filter may become clogged. It is therefore a good idea to clean it from time to time.

**To clean the water inlet filters:**

1. Close the water tap.
2. Remove the water inlet hose from the water tap.
3. Clean the filter in the inlet hose with a stiff brush.

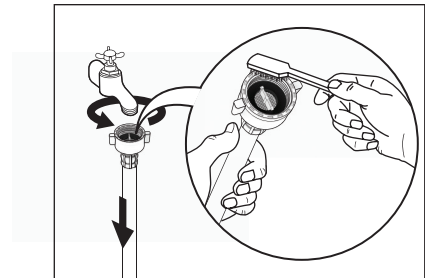

4. Remove the inlet hose behind the appliance.

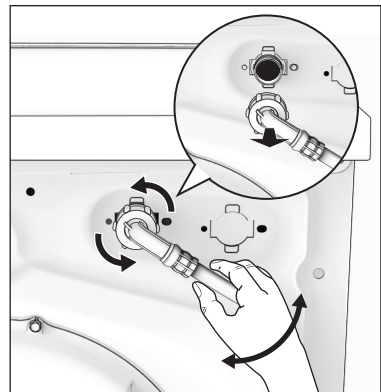

5. Clean the filter in the valve with a stiff brush or a towel.

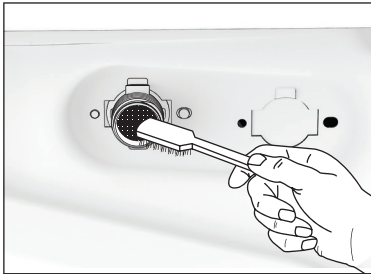

6. Install the inlet hose again. Make sure that the couplings are tight to prevent leakages.
7. Open the water tap.

## 8.8 Frost Precautions

If the appliance is installed in an area where the temperature can be less than 0 °C, remove the remaining water from the inlet hose and the drain pump.

### Emergency Drain

1. Disconnect the main plug from the main socket. Turn off the water tap.
2. Remove the water inlet hose.
3. Remove the drain hose from the rear support and unhook it from sink or spigot.

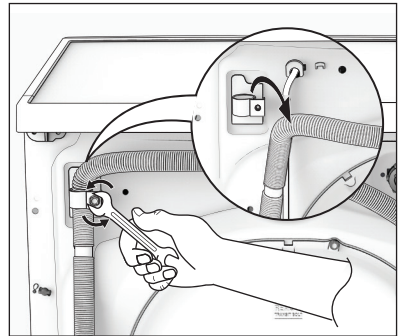

4. Put the end of the drain and inlet hose in a container. Let the water flow out of the hoses.

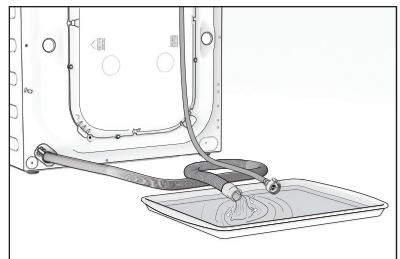

5. When no more water flows, install the inlet hose and the drain hose again.



#### NOTE

Make sure that the temperature is more than 0 °C before you use the appliance again.

## 9. TROUBLESHOOTING

### 9.1 Possible Failures

Certain problems are due to lack of simple maintenance or oversights, which can be solved easily without calling out an engineer. Before contacting your local Service Centre, please check trouble-shooting below.

Once the problem has been eliminated, press the Start/Pause button to restart the program. If after all checks, the problem persists, contact your local Service Centre.

 **WARNING!** Deactivate the appliance before you do the checks.

### Alarm Code:

<b>E10</b>	The appliance does not fill with water properly.
<b>E20</b>	The appliance does not drain the water.
<b>E40</b>	The appliance door is open or not closed correctly. Please check the door!
<b>EHO</b>	The main supply is unstable. Wait until the main supply is stable.
<b>E91</b>	No communication between electronic elements of the appliance. Switch off and switch on again.

Malfunction	Possible cause	Solution
<b>Machine does not start:</b>	The door has not been closed. (Error code: E 40 )	Close the door firmly.
	The plug is not properly inserted into the power socket.	Insert the plug into the power socket.
	There is no power at the socket.	Please check your domestic electrical installation.
	The Start/Pause touchpad has not been pressed.	Press the Start/Pause touchpad.
	The "Delay End" has been selected.	If the laundry are to be washed immediately, cancel the "Delay End".
	The Main supply is unstable. (If EHO appears on the display.)	Wait until the main supply is stable. Appliance will start automatically.
<b>Machine does not fill the water:</b>	The water tap is closed. (Error code: E 10 )	Open the water tap.
	The inlet hose is squashed or kinked. (Error code: E 10 )	Check the inlet hose connection.
	The filter in the inlet hose is blocked. (Error code: E 10 )	Clean the water inlet hose filter.
	The door is not properly closed. (Error code: E 40 )	Close the door firmly.
<b>Machine fills then empties immediately:</b>	The end of the drain hose is too low. (Error code: E 10 )	Refer to relevant paragraph in "water drainage" section.

<b>Malfunction</b>	<b>Possible cause</b>	<b>Solution</b>
<b>Machine does not empty and/or does not spin:</b>	The drain hose is squashed or kinked. (Error code: E20)	Check the drain hose connection.
	The drain pump is clogged. (Error code: E20)	Clean the drain filter.
	The option "Rinse Hold" has been selected.	Press Start/Pause touchpad to drain the water or select spin program.
	The laundry is not evenly distributed in the drum.	Pause the machine and redistribute laundry manually.
<b>There is water on the floor:</b>	Too much detergent or unsuitable detergent (creates too much foam) has been used.	Reduce detergent quantity and use correct type of detergent (refer page 22).
	Check whether there are any leaks from one of the inlet hose fittings. It is not always easy to see this as the water runs down the hose; check to see if it is damp.	Check the water inlet hose connection.
	The drain hose is damaged.	Call Service.
<b>Unsatisfactory washing results:</b>	Too little detergent or unsuitable detergent has been used.	Increase detergent quantity or use different detergent (refer page 22).
	Stubborn stains have not been treated prior to washing.	Use commercial products to treat the stubborn stains.
	The correct temperature was not selected.	Check if you have selected the correct temperature.
	Excessive laundry load.	Reduce load.
<b>The door will not open:</b>	The program is still running.	Wait until the end of cycle.
	There is water in the drum.	You must drain the water to open the door (refer "Opening The Door" on page 19).
	This problem may be caused by a failure of the appliance.	Contact Service. If you need to open the door, please read carefully "Emergency door opening" on page 30.
<b>Machine vibrates or is noisy:</b>	The transit bolts and packing have not been removed.	Check the correct installation of the appliance.
	The support feet have not been adjusted.	Check the correct levelling of the appliance.

<b>Malfunction</b>	<b>Possible cause</b>	<b>Solution</b>
<b>Machine vibrates or is noisy:</b>	The laundry is not evenly distributed in the drum.	Pause the machine and redistribute laundry manually.
	There is very little laundry in the drum.	Load more laundry.
	Unstable floors eg. wooden floors.	Refer to relevant paragraph in "Positioning" section.
<b>Cycle time longer than displayed:</b>	Detergent over dose.	Reduce the detergent quantity or use another one. (Refer page 22 "Detergents Type And Quantity Of Detergent").
	Machine unbalance.	Redistribute laundry manually in the drum and start the spin phase again.
<b>The cycle is shorter than the time displayed.</b>	The appliance calculated a new time according to the laundry load.	
<b>Spinning starts late or machine does not spin:</b>	<p>The electronic unbalance detection device has cut in because the laundry is not evenly distributed in the drum. The laundry is redistributed by reverse rotation of the drum.</p> <p>This may happen several times before the unbalance disappears and normal spinning can resume. If, after 10 minutes, the laundry is still not evenly distributed in the drum, the machine will not spin. In this case, redistribute the load manually and select the spin program.</p>	Pause the machine and redistribute laundry manually.
<b>Machine makes an unusual noise:</b>	Machine not installed properly.	Make sure the levelling of the appliance is correct. Refer to "Installation".
	Transit bolts or packaging not removed.	Make sure that the packaging and/or the transit bolts are removed. Refer to "Unpacking".
	The load may be too small.	Add more laundry in the drum.
<b>No water is visible in the drum:</b>	Machines based on modern technology operate very economical-ly using very little water without affecting performance.	

### **i** NOTE

If you are unable to identify or solve the problem, contact our service centre. Before calling service centre, make a note of the model, serial number and purchase date of your machine: the Service Centre will require this information.

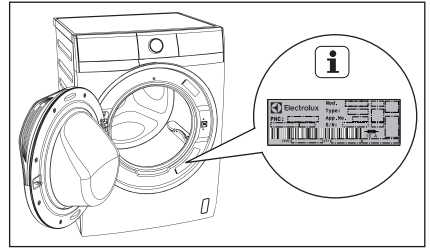

## 9.2 Emergency Door Opening

In case of power failure or appliance failure, the appliance door remains locked. The wash program continues when power is restored. If the door remains locked in case of failure, it is possible to open it using the emergency unlock feature.

**Before opening the door:**



**WARNING!**

**Make sure that the water temperature and the laundry are not hot. Wait until they cool down if necessary.**

**Make sure that the water level inside the drum is not too high. If necessary, perform an Emergency Drain (see page 26).**

**Make sure that the drum is not rotating. Wait until the drum stops rotating if necessary.**

**To open the door proceed as follows:**

1. Rotate the program knob to "Off" position to switch the appliance off.
2. Disconnect the mains plug from the mains socket.
3. Remove the cover door, as picture below.
4. Using a suitable tool to pulling the emergency unlock strap (red strap) downward twice (you will hear "click" sound) and hold it, at the same time pull the door handle to open the door.

If the door cannot open while holding the strap, try to release it then open the door.

5. Take out the laundry.
6. Re-assemble the cover door.

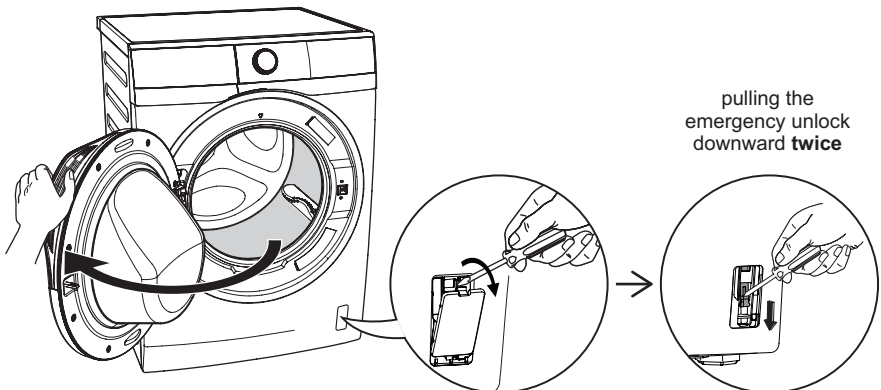

## 10. TECHNICAL DATA

<b>Dimensions (Height / Width / Depth)</b>	EWF7524D3WB / EWF8024D3WB : 848 x 596.5 x 567.5 mm EWF9024D3WB : 848 x 596.5 x 659.0 mm		
<b>Power supply (Voltage / Frequency)</b>	220-240 V~ / 50 Hz		
<b>Total power absorbed</b>	2000 W		
<b>Minimum fuse protection</b>	10 A		
<b>Water supply pressure (Maximum / Minimum)</b>	0.8 MPa / 0.05 MPa		
<b>Maximum dry clothes capacity</b>	<b>Program</b>	EWF7524D3WB EWF8024D3WB	EWF9024D3WB
	<b>Off</b>	-	-
	<b>Cottons</b>	<b>Max.</b> <sup>1)</sup>	<b>Max.</b> <sup>1)</sup>
	<b>Mixed</b>	4 kg	4 kg
	<b>Delicates</b>	4 kg	4 kg
	<b>Bedding</b>	3 kg	3 kg
	<b>Energy Saver</b>	<b>Max.</b>	<b>Max.</b>
	<b>Tub Clean</b>	-	-
	<b>Spin</b>	<b>Max.</b>	<b>Max.</b>
	<b>Rinse + Spin</b>	<b>Max.</b>	<b>Max.</b>
	<b>Baby Care</b>	4 kg	4 kg
	<b>Quick 15</b>	1.5 kg	1.5 kg
	<b>Daily 39</b>	4 kg	5 kg
<b>Full Wash 60</b>	<b>Max.</b>	<b>Max.</b>	
<b>Favourite</b>	-	-	
<b>Spin speed (Maximum / Minimum)</b>	1200 rpm / 400 rpm		

<sup>1)</sup> Maximum capacity depended on the model of the Washing Machine (see defined on the control panel).

## 11. INSTALLATION

### 11.1 Unpacking



#### CAUTION!

All transit bolts and packing must be removed before using the appliance.

You are advised to keep all transit devices so that they can be refitted if the machine ever has to be transported again.

1. Use gloves. Cut and remove four cut out straps as shown.

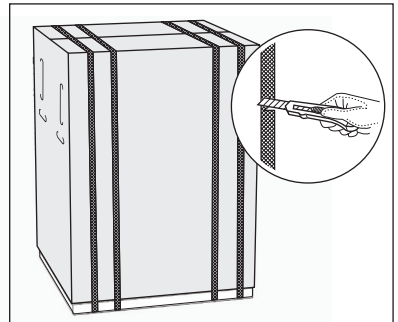

2. Remove the carton box. Remove the polystyrene packaging materials.  
Remove the plastic bag which cover the machine.

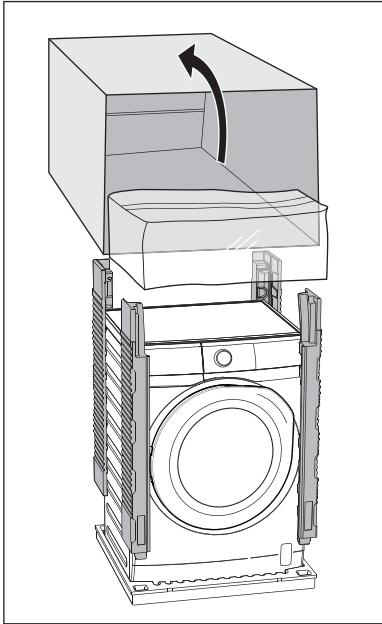

3. Open the door. Remove the polystyrene piece from the door seal and all the items from the drum.

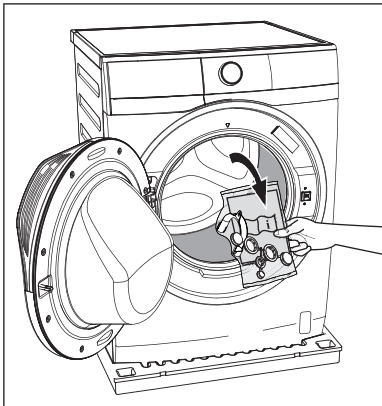

4. Put one of the polystyrene packaging elements on the floor behind the appliance. Carefully put down the appliance with the rear side on it. Make sure not to damage the hoses.

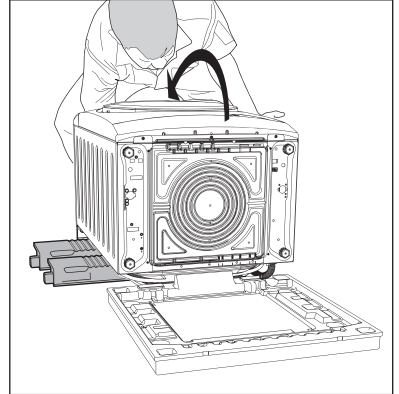

5. Remove the polystyrene base.

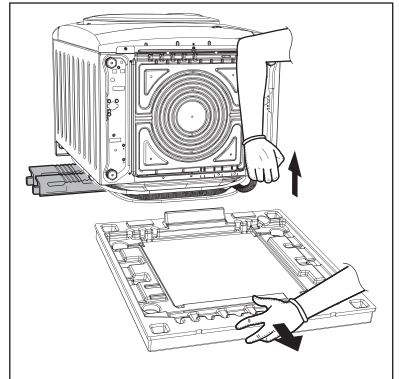

6. Pull up the appliance in vertical position.
7. Remove the power supply cable and the drain and inlet hoses from the hose holders (A) on the rear of the appliance.



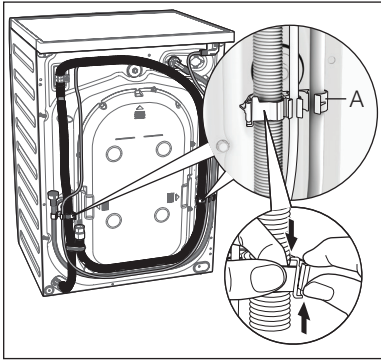

8. Remove the three transit bolts.
9. Pull out the plastic spacers.

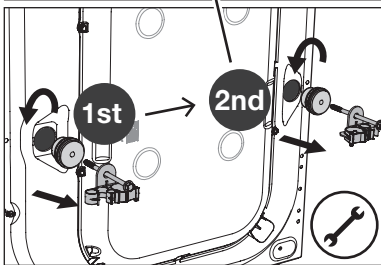
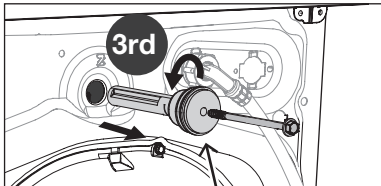

10. Put the plastic caps in the holes (X3). You can find these caps in the user manual bag.

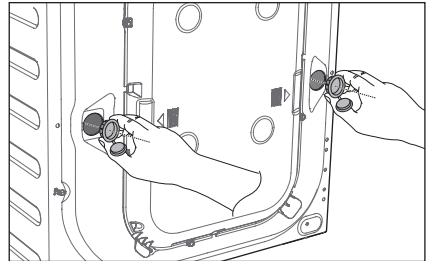
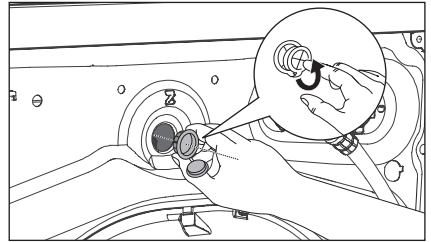
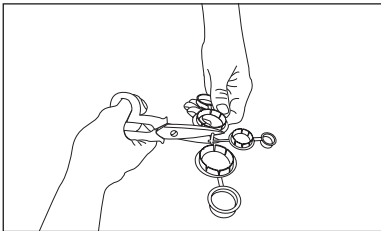

## 11.2 Positioning

It is important that your washing machine stands firm and leveled on the floor to ensure correct operation. The appliance must not be installed behind a lockable door, a sliding door or a door with a hinge on the opposite side to avoid restricting the washing machine door.

Use a spirit level on the top and side of the washing machine to check the levels.

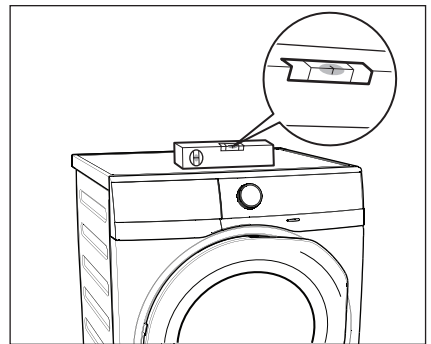

If you do not have a spirit level, as a guide use the edge of a door frame, cupboard or bench to check that the washing machine is leveled.

Loosen or tighten the feet to adjust the level. A correct adjustment of the appliance level prevents vibration, noise and the movement of the appliance when in operation.

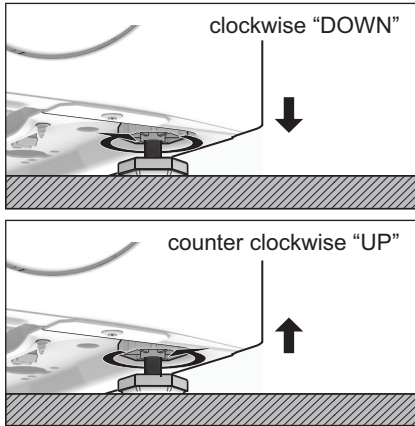

When the washing machine is levelled, try to rock it from corner to corner. If it does rock, adjust the legs again until it is levelled and does not rock.

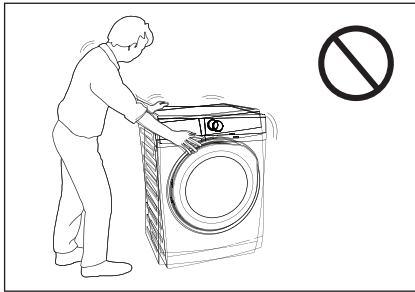

Never place cardboard, wood or similar materials under the machine to compensate for any unevenness in the floor. Install the machine on a flat hard floor. Make sure that air circulation around the machine is not impeded by carpets, rugs etc.

Check that the machine does not touch the wall or cupboard units.

### 11.3 Water Inlet

Connect the water inlet hose to a tap with 3/4" BSP thread.

Use the hose supplied with the washing machine. **DO NOT USE OLD HOSES.**

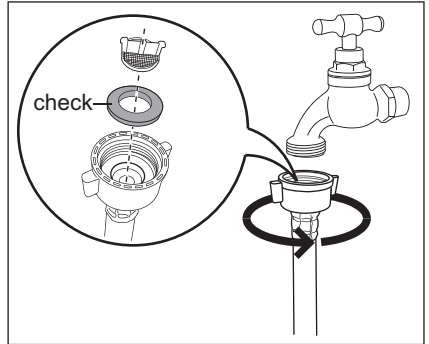

The inlet hose must not be lengthened. If it is too short and you do not wish to move the tap, you will have to purchase a new, longer hose specially designed for this type of use.

Loosen the ring nut to angle the hose to the left or right depending on the position of your water tap. Do not place the inlet hose downwards. After positioning the inlet hose, be sure to tighten the ring nut again to prevent leaks.

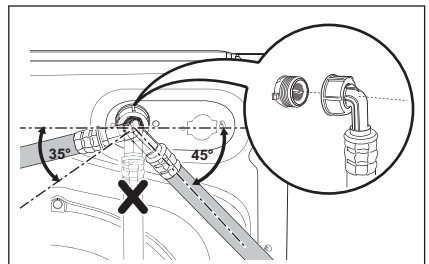

### 11.4 Water Drainage

The end of the drain hose can be positioned in three ways:

- **Hooked over the edge of a sink,** using the plastic hose guide supplied with the machine.

**Fitting Hose Guide**

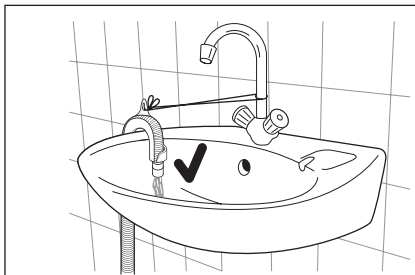
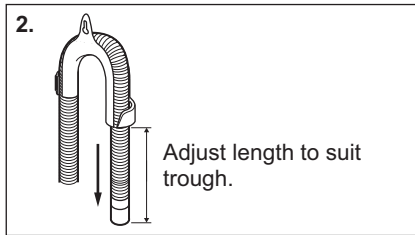
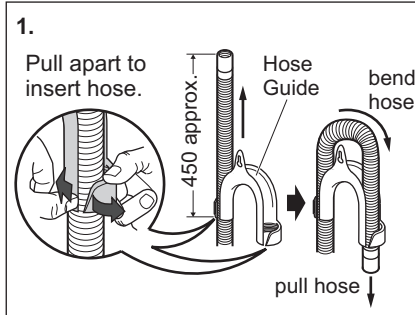

In this case, make sure the end cannot come unhooked when the machine will be emptied. This could be done by tying it to the tap with a piece of string or attaching it to the wall.

- **In a sink, drain pipe branch.**

This branch must be above the trap so that the bend is at least 60 cm above the ground.

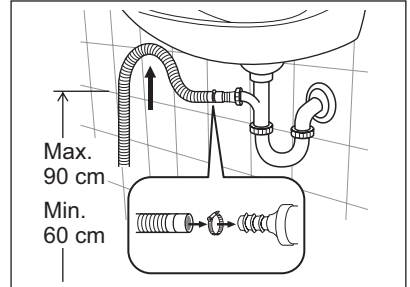

Push the drain hose onto the spigot and secure with a clip, ensure a loop is formed in the drain hose to prevent waste from the sink entering the appliance.

- **Directly into a drain pipe,** at a height of not less than 60 cm and not more than 90 cm.

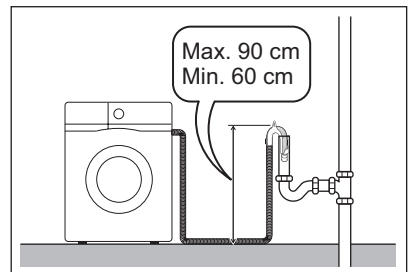

The end of the drain hose must always be ventilated, i.e. the inside diameter of the drain pipe must be larger than the outside diameter of the drain hose.

The drain hose must not be twisted or curled. Run it along the floor; only the part near the drainage point must be raised.

For the correct functioning of the machine, the drain hose must remain hooked on the proper support piece situated on the top part of back side of the appliance.

## 11.5 Electrical Connection

This machine is designed to operate on a 220-240 V, single-phase, 50 Hz supply.

**“An incorrect power supply may void your warranty.”**

Check that your domestic electrical installation can take the maximum load required (2.0 kW), also taking into account any other appliances in use.



### **CAUTION!**

**Connect the machine to an earthed socket outlet.**



**The manufacturer declines any responsibility for damage or injury through failure to comply with the above safety precautions.**



**Should the appliance power supply cable need to be replaced, this shall be carried out by our Service Centre.**

When the appliance is installed, the power supply cable must be easily accessible.

---

## 12. ENVIRONMENT CONCERNS

### 12.1 Packaging Materials



The materials marked with the symbol  are recyclable.

>PE<=polyethylene

>PS<=polystyrene

>PP<=polypropylene

This means that they can be recycled by disposing them properly in appropriate collection containers.

### 12.2 Old Machine

Use authorized disposal sites for your old appliance. Help to keep your country tidy!

The symbol  on the product or on its packaging indicates that this product may not be treated as household waste.

Instead it shall be handed over to the applicable collection point for the recycling of electrical and electronic equipment. By ensuring this product is disposed of correctly, you will help prevent potential negative consequences for the environment and human health, which could otherwise be caused by inappropriate waste handling of this product.

For more detailed information about recycling of this product, please contact your local city office, your household waste disposal service or the shop where you purchased the product.

### 12.3 Ecological Hints

To save water, energy and to help protect the environment, we recommend that you follow these tips:

- Normally soiled laundry may be washed without prewashing in order to save detergent, water and time (the environment is protected too!).
- The machine works more economically if it is fully loaded.
- With adequate pre-treatment, stains and limited soiling can be removed; the laundry can then be washed at a lower temperature.
- Measure out detergent according to the water hardness, the degree of soiling and the quantity of laundry being washed.

## MAKLUMAT PENTING YANG BOLEH MEMBERIKAN KESAN TERHADAP WARANTI PENGILANG ANDA

Mematuhi arahan penggunaan dalam manual ini adalah amat penting untuk kesihatan dan keselamatan. Kegagalan untuk mematuhi keperluan dalam manual ini dengan sewajarnya boleh menyebabkan kecederaan diri, kerosakan harta dan menjejaskan keupayaan anda untuk membuat tuntutan di bawah waranti pengilang Electrolux yang disediakan dengan produk anda. Produk hendaklah digunakan, dipasang dan dikendalikan selaras dengan manual ini. Anda mungkin tidak boleh membuat tuntutan terhadap waranti pengilang Electrolux sekiranya kerosakan produk anda berlaku disebabkan kegagalan untuk mematuhi manual ini.

## KAMI MEMIKIRKAN TENTANG DIRI ANDA

Terima kasih kerana membeli perkakas Electrolux. Anda telah memilih produk yang membawa bersamanya pengalaman profesional dan inovasi yang telah sudah berkembang sejak berdekad-dekad lamanya. Pintar dan bergaya, ia telah direka bentuk dengan memikirkan tentang diri anda. Maka, setiap kali anda menggunakannya, anda boleh berasa yakin mengetahui bahawa anda akan memperoleh hasil yang hebat. Selamat datang ke Electrolux.

**layari laman web kami untuk:**



Dapatkan nasihat penggunaan, risalah, penyelesaian masalah, maklumat servis: [www.electrolux.com](http://www.electrolux.com)

## PENJAGAAN DAN PERKHIDMATAN PELANGGAN

Kami mengesyorkan penggunaan bahagian ganti tulen. Semasa menghubungi Servis, pastikan bahawa anda telah menyediakan data yang berikut. Maklumatnya boleh didapati pada plat label. Model, PNC, Nombor Siri.

 Amaran / Maklumat Awas-Keselamatan.

 Maklumat dan petua umum.

 Maklumat alam sekitar.

**Tertakluk pada perubahan tanpa notis.**

## KANDUNGAN

<b>1. MAKLUMAT KESELAMATAN</b>	
1.1 Syarat-Syarat Penggunaan.....	40
1.2 Keselamatan Kanak-Kanak.....	41
1.3 Keselamatan Am.....	41
1.4 Pemasangan.....	42
1.5 Penggunaan.....	42
<b>2. HURAIAN PRODUK</b>	
2.1 Bahagian.....	43
2.2 Aksesori.....	44
<b>3. PANEL KAWALAN</b>	
3.1 Penerangan Panel Kawalan.....	45
3.2 Carta Program.....	46
3.3 Pilihan Program Keserasian.....	48
3.4 Opsyen.....	49
3.5 Tetapan.....	51
3.6 Pad sentuh Mula/Jeda (▷  ) dan Tambah Pakaian (↻).....	52

<b>4. SEBELUM PENGGUNAAN YANG PERTAMA .....</b>	<b>52</b>
<b>5. PENGGUNAAN HARIAN</b>	
5.1 Memuat Cucian .....	53
5.2 Mengguna Detergen dan Perapi Tambahan .....	53
5.3 Tetapan Opsyen .....	54
5.4 Memula Program (▷  ) .....	55
5.5 Gangguan Program .....	55
5.6 Menukar Program .....	55
5.7 Menukar Opsyen .....	55
5.8 Membuka Pintu .....	55
5.9 Di Penghujung Program .....	55
5.10 Apabila Program Membasuh Selesai, Tetapi Terdapat Air Di Dalam Dram .....	56
5.11 AUTO Off Mod .....	56
<b>6. PETUA MEMBASUH</b>	
6.1 Mengasing Pakaian .....	57
6.2 Suhu .....	57
6.3 Sebelum Memuat Pakaian .....	57
6.4 Muatan Maksimum .....	57
6.5 Menanggal Kotoran .....	57
6.6 Jenis Bahan Pencuci dan Kuantiti Bahan Pencuci .....	58
<b>7. SIMBOL KOD BASUH ANTARABANGSA .....</b>	<b>59</b>
<b>8. PENJAGAAN DAN PEMBERSIHAN</b>	
8.1 Pembersihan Luar .....	60
8.2 Menanggalkan Kesan Kapur .....	60
8.3 Selepas Setiap Cucian .....	60
8.4 Basuhan Penyelenggaraan Dengan Program "Tub Clean" .....	60
8.5 Membersih Petak Dispenser .....	60
8.6 Membersih Ceruk Petak .....	61
8.7 Membersih Penapis Aliran Air Masuk .....	61
8.8 Langkah Berwaspada Fros .....	62
<b>9. PENYELESAIAN MASALAH</b>	
9.1 Kegagalan Kemungkinan .....	63
9.2 Membuka Pintu Mesin Semasa Kecemasan .....	66
<b>10. DATA TEKNIKAL .....</b>	<b>67</b>
<b>11. PEMASANGAN</b>	
11.1 Mengeluarkan .....	67
11.2 Kedudukan Mesin .....	69
11.3 Saliran Air Masuk .....	70
11.4 Penyaliran Air .....	70
11.5 Sambungan Elektrik .....	72
<b>12. KEPRIHATINAN ALAM SEKITAR</b>	
12.1 Bahan Pembungkusan .....	73
12.2 Mesin Lama .....	73
12.3 Petua Ekologi .....	73

# 1. MAKLUMAT KESELAMATAN

## 1.1 Syarat-Syarat Penggunaan

Perkakas ini bertujuan untuk digunakan dalam aplikasi rumah dan aplikasi yang serupa seperti:

- kawasan dapur kakitangan di kedai-kedai, pejabat-pejabat dan lain-lain persekitaran kerja rumah-rumah ladang;
- rumah ladang;
- oleh pelanggan di hotel, motel, dan lain-lain jenis persekitaran kediaman;
- jenis persekitaran tempat tidur dan sarapan;
- kawasan untuk kegunaan umum di blok rumah pangsa atau dalam kedai dobi.

 **AMARAN!** Perkakas tidak boleh dibekalkan melalui peranti pensuisan luaran, seperti pemasa, atau disambungkan ke litar yang sentiasa dihidupkan dan dimatikan oleh utiliti.

Demi kepentingan keselamatan anda dan untuk memastikan penggunaan yang betul, sila baca panduan pengguna ini dengan berhati-hati sebelum memasang dan mengguna mesin ini, termasuk petua dan amaran.

Untuk mengelakkan kesilapan dan kemalangan, sila memastikan bahawa semua orang yang menggunakan mesin ini memahami cara pengendalian dan ciri-ciri keselamatannya.

Simpan arahan ini dan pastikan ia tetap berada bersama mesin ini jikalau dipindahkan atau dijual, supaya semua orang yang menggunakan mesin ini akan mendapat maklumat yang betul mengenai penggunaan dan keselamatan alat ini.



## 1.2 Keselamatan Kanak-Kanak

- Mesin basuh ini bukan bertujuan untuk digunakan oleh kanak-kanak kecil atau orang yang uzur tanpa penyeliaan.
- Kanak-kanak hendaklah diselia untuk memastikan mereka tidak main dengan perkakas tersebut.
- Komponen pembungkusan (cth. lapik plastik, polistirena) boleh membahayakan kanak-kanak - awas sesak nafas! Jauhkan daripada capaian kanak-kanak.
- Simpan semua detergen di tempat yang selamat dan jauh daripada capaian kanak-kanak.
- Pastikan kanak-kanak atau haiwan peliharaan tidak memanjat masuk ke dalam dram.
- Mesin basuh ini disediakan dengan fungsi keselamatan kanak-kanak (  ) untuk menghindari kanak-kanak daripada tertukar program basuh dengan tidak sengaja. (Lihat halaman 51)

## 1.3 Keselamatan Am

- Adalah merbahaya untuk mengubah spesifikasi atau cuba mengubah suai produk ini dalam apa-apa cara sekali pun.
- Semasa program basuh bersuhu tinggi, kaca pintu boleh menjadi panas. Jangan sentuh !
- Pastikan haiwan peliharaan tidak memanjat masuk ke dalam dram. Untuk mengelakkan perkara ini, sila periksa dalam dram sebelum menggunakan perkakas.
- Objek seperti duit syiling, pin, paku, skru, batu atau apa-apa benda keras dan tajam boleh menyebabkan kerosakan yang serius dan tidak boleh dimasukkan ke dalam mesin.
- Basuh barang kecil seperti sarung kaki, les, tali pinggang boleh basuh di dalam beg basuh atau sarung bantal kerana barang seperti ini boleh termasuk ke dalam ruang antara tab dan dram dalaman.
- Hanya gunakan kuantiti pelembut pakaian dan detergen yang disarankan. Kerosakan kepada fabrik atau peralatan boleh berlaku jika anda terlebih muatkan. Rujuk cadangan kuantiti daripada pengilang.
- Jangan gunakan mesin pembasuh untuk membasuh barang dengan tetulang, barang tanpa jahit tepi atau terkoyak.
- Sentiasa cabut keluar plag perkakas dan matikan bekalan air selepas digunakan, dibersihkan dan diselenggarakan.

- Alat ini tidak ditulukan untuk penggunaan orang (termasuk kanak-kanak) yang kurang upaya fizikal, sensitiviti deria atau mental, atau kurang pengalaman atau pengetahuan, melainkan mereka telah diberi penyeliaan atau arahan mengenai penggunaan alat ini oleh orang yang bertanggungjawab ke atas keselamatan mereka.
- Anda dilarang untuk memperbaiki mesin ini sendiri, walau dalam apa keadaan sekali pun. Kerja-kerja pembaikan yang dijalankan oleh orang yang tidak berpengalaman mungkin menyebabkan kecederaan atau malfungsi yang serius. Hubungi Pusat Servis setempat anda.

## 1.4 Pemasangan

- Perkakas ini berat. Hendaklah berjaga-jaga semasa memindahkannya.
- Semasa perkakas dikeluarkan daripada bungkusannya, periksa untuk pastikan tiada kerosakan. Jika berasa ragu, jangan gunakannya dan hubungilah Pusat Servis.
- Semua bolt pengangkutan dan bahan pembungkusan mesti dikeluarkan sebelum penggunaan. Kerosakan serius boleh berlaku kepada produk dan kepada harta jika tidak mematuhi langkan ini. Lihat bahagian yang relevan dalam manual pengguna ini.
- Setelah memasang perkakas ini, periksa bahawa ia tidak berdiri di atas hos saluran masuk dan saluran keluar, dan permukaan kerja tidak menekan kabel bekalan elektrik pada dinding.
- Jika mesin terletak di atas lantai berkarpet, sila laraskan kaki untuk membenarkan udara beredar dengan bebas.
- Sentiasa pastikan, bahawa tiada kebocoran air daripada hos dan sambungannya selepas pemasangan.
- Sebarang kerja paip untuk memasang perkakas ini harus dilakukan oleh tukang paip berkelayakan.
- Sebarang kerja elektrik untuk memasang perkakas ini harus dilakukan oleh tukang elektrik berkelayakan.



**Boleh menyebabkan kejutan elektrik! Jika mesin tidak disambungkan pada alur keluar soket yang dibumikan. Jangan sentuh pakaian yang basah.**



**Atas sebab-sebab keselamatan, jangan gunakan adapter berganda, wayar sambungan dan penyesuai pelbagai plag.**

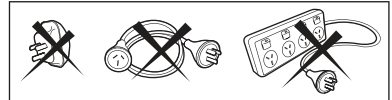

## 1.5 Penggunaan

- Basuh fabrik yang ditujukan untuk dibasuh dengan mesin sahaja. Arahan di label pakaian hendaklah dipatuhi.
- Jangan memuatkan perkakas secara berlebihan. Lihat bahagian yang relevan dalam manual pengguna ini.
- Sebelum membasuh, pastikan semua poket dikosongkan dan butang serta zip diketatkan. Elakkan daripada membasuh pakaian berbulu atau koyak dan cuci kotoran seperti cat, dakwat, karat dan kesan rumput sebelum pembasuhan. Coli berwayar bawah TIDAK boleh dibasuh dengan mesin.
- Pakaian yang telah tercemar dengan produk petrol mudah meruap tidak boleh dibasuh dengan mesin. Jika cecair pembersihan mudah meruap digunakan, berhati-hati untuk memastikan bahawa cecair tersebut ditanggalkan daripada pakaian sebelum memasukkannya ke dalam mesin.
- Jangan tarik kabel bekalan kuasa untuk mencabut palam daripada soket; sentiasa pegang, palam dan cabut.
- Jangan gunakan mesin basuh jika kabel bekalan kuasa, panel kawalan, permukaan kerja atau tapak mesin rosak supaya bahagian dalam mesin basuh tersebut boleh diakses.

## 2. HURAIAN PRODUK

### 2.1 Bahagian

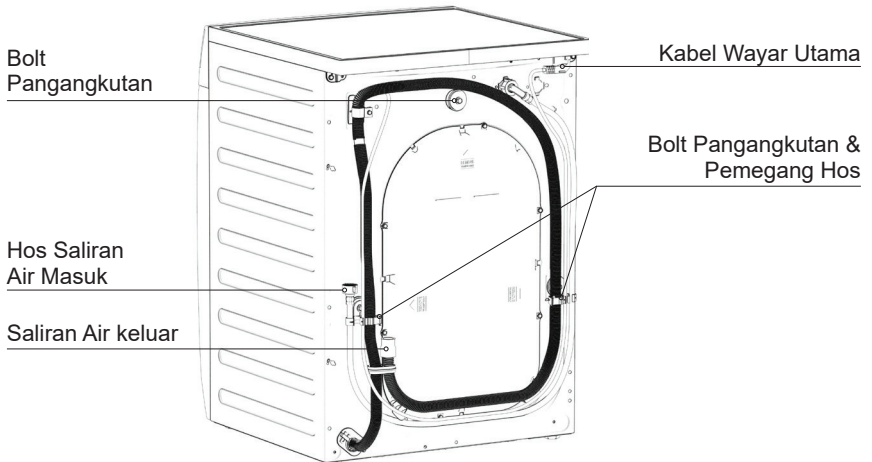
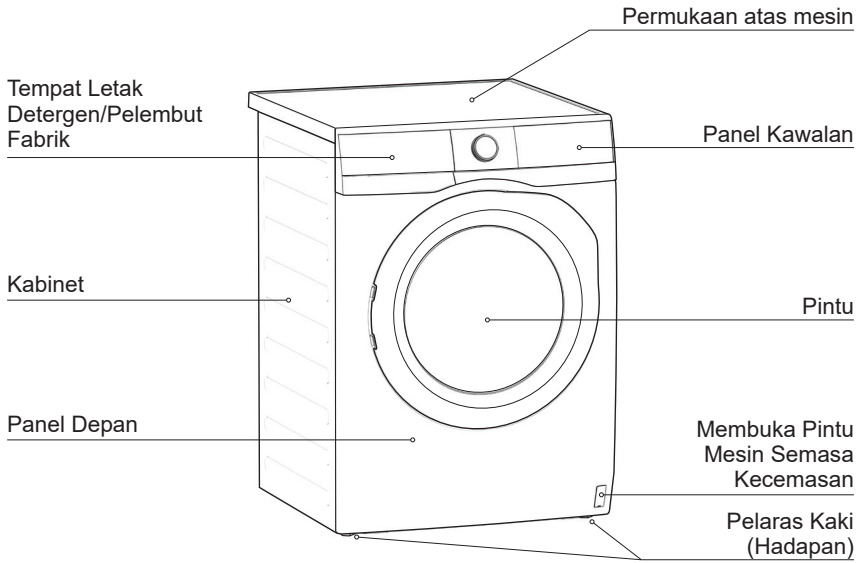

Tempat Letak Detergen/Pelembut Fabrik (lihat halaman 53, 60)

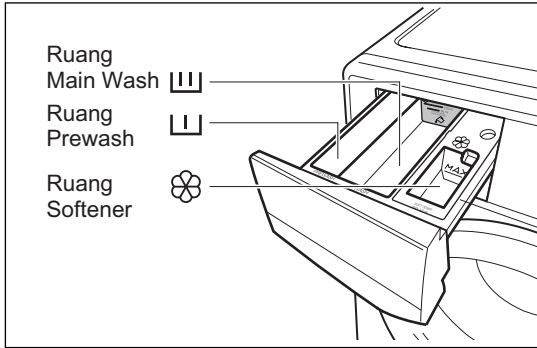

Pintu (apabila dibuka) (lihat halaman 53)

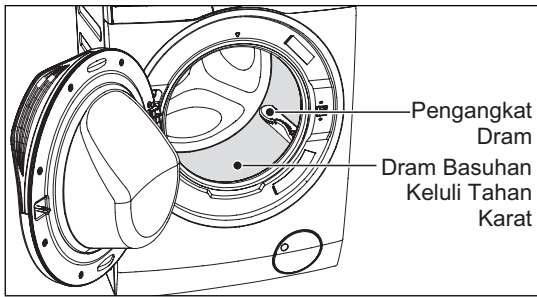

Membuka Pintu Mesin Semasa Kecemasan

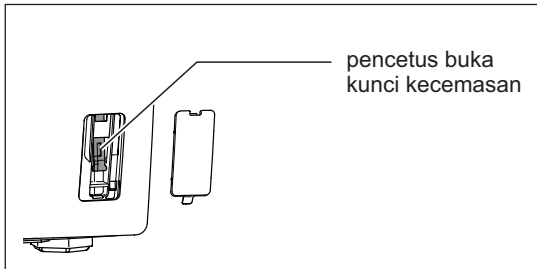

Pelaras Kaki

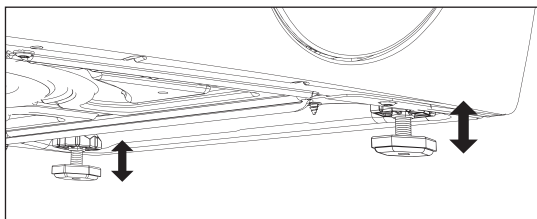

Bolt Pangangkutan (apabila dialih keluar)

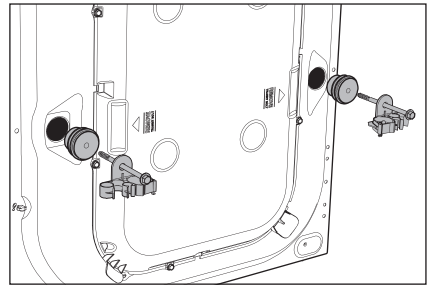
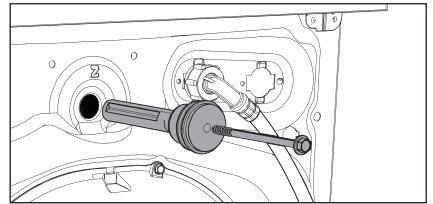

 **Semua bolt pengangkutan (3 alat) mesti dikeluarkan sebelum menggunakan perkakas.**

## 2.2 Aksesori

### Penutup plastik

Untuk menutup lubang pada bahagian sisi kabinet selepas pemuangan bolt pengangkutan.



### Panduan hos plastik

Untuk menyambung hos aliran kepada pinggir sinki.

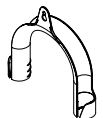

## 3. PANEL KAWALAN

### 3.1 Penerangan Panel Kawalan

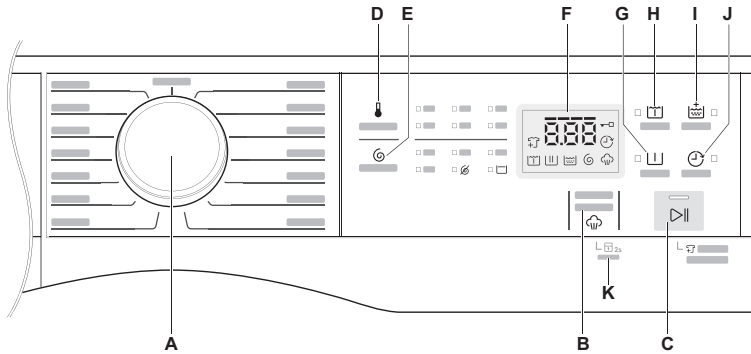

<b>A</b> Tombol Program	<b>H</b> Pad Sentuh Soak (Rendam)
<b>B</b> Pad Sentuh Wap	<b>I</b> Pad Sentuh Bilas Tambahan
<b>C</b> Pad Sentuh Mula/Jeda	<b>J</b> Pad Sentuh Tunda Tamat
<b>D</b> Pad Sentuh Lara Suhu	<b>K</b> Pilihan Keselamatan Kanak-Kanak
<b>E</b> Pad Sentuh Pilihan Kelajuan Putaran	
<b>F</b> Paparan	
<b>G</b> Pad Sentuh Prabasuh	

#### Paparan

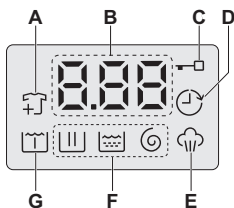

<b>A</b> Ikon Fungsi Tambah
<b>B</b> Kitaran masa yang cuci/Tunda Tamat
<b>C</b> Ikon Penunjuk Kunci Pintu
<b>D</b> Ikon Tunda Tamat
<b>E</b> Fasa Wap
<b>F</b> Kelajuan Putaran Ikon Fasa Pencucian: <ul style="list-style-type: none"> <li>▯▯▯ Fasa Cuci,</li> <li>▯▯▯ Fasa Bilas,</li> <li>⊙ Fasa Putaran</li> </ul>
<b>G</b> Fasa Rendam

### 3.2 Carta Program







<b>Program; Suhu</b>	<b>Max. Kelajuan Putaran</b>	<b>Muatan Maks. (Pakaian kering)</b>	<b>Jenis muatan dan tahap kotoran</b>
<b>Off</b> (Mematikan)	–	–	Meletakkan “Off” kepada tetapkan semula program/Mematikan mesin.
<b>Cottons</b> (Kapas); Dingin ke 90°C	1200 rpm	<b>Max.<sup>1)</sup></b>	Kapas putih dan berwarna.
<b>Mixed</b> (Campur); Dingin ke 60°C	1200 rpm	4 kg	Sintetik atau campuran item fabrik.
<b>Delicates</b> (Kain lembut); Dingin ke 40°C	1200 rpm	4 kg	Fabrik lembut seperti akrilik, viscose, item poliester.
<b>Bedding</b> (Cadar Katil); Dingin ke 40°C	800 rpm	3 kg	Program kahs untuk satu selimut sintetik, duvet, cadar katil dan lain-lain.
<b>Energy Saver</b> (Menjimatkan Tenaga); 40°C dan 60°C <sup>1)</sup>	1200 rpm	<b>Max.<sup>1)</sup></b>	Putih dan mudah luntur warna, kapas dengan kotoran normal. Tetapkan program ini untuk mempunyai hasil cucian yang baik dan kurangkan penggunaan tenaga. Masa bagi program pembasuhan dilanjutkan.
<b>Tub Clean</b> (Pembersihan Tab) 60°C	–	–	Untuk membersihkan dram basuhan.
<b>Spin</b> (Putar)	1200 rpm	<b>Max.<sup>1)</sup></b>	Untuk memusingkan basuhan dan mengosongkan air dalam dram.
<b>Rinse + Spin</b> (Bilas) + (Putar)	1200 rpm	<b>Max.<sup>1)</sup></b>	Untuk membilas dan memusingkan basuhan.
<b>Baby Care</b> (Bayi); Dingin ke 40°C	1200 rpm	4 kg	Baju kapas bayi dan item knit yang lembut dengan kekotoran normal.

<b>Program; Suhu</b>	<b>Max. Kelajuan Putaran</b>	<b>Muatan Maks. (Pakaian kering)</b>	<b>Jenis muatan dan tahap kotoran</b>
<b>Quick 15</b> (Cepat); Dingin ke 30°C	1200 rpm	1.5 kg	Item fabrik sintetik dan campuran. Kotoran sedikit dan item untuk disegarkan semula.
<b>Daily 39</b> (Harian 39 ; 30°C ke 40°C	1200 rpm	EWFF7524D3WB EWFF8024D3WB 4 kg EWFF9024D3WB 5 kg	Setiap hari memakai pakaian kapas berwarna seperti kemeja, blaus, tuala, dan seluar dalam. Sesuai untuk tanah yang rendah.
<b>Full Wash 60</b> (Basuh Penuh 60 minit) 30°C ke 60°C	1200 rpm	<b>Max.<sup>1)</sup></b>	Setiap hari memakai pakaian kapas berwarna seperti kemeja, blaus, tuala, dan seluar dalam. Sesuai untuk permukaan tanah yang normal.

1) Kapasiti maksimum bergantung pada model Mesin Cuci (lihat ditentukan pada panel kawalan).

2) Program Penjimat Tenaga dengan opsiyen 60 °C dicadangkan untuk muatan penuh kapas dengan kotoran basa.

### 3.3 Pilihan Program Keserasian

Program	Pilihan						
	 No Spin	 Rinse Hold	 Soak	 Extra Rinse	 Prewash	 Delay End	 Hygienic Care <sup>1)</sup>
Cottons	■	■	■	■	■	■	■
Mixed	■	■	■	■	■	■	■
Delicates	■	■	■	■	■	■	■
Bedding	■	■	■	■	■	■	■
Energy Saver	■	■	■	■	■	■	■
Tub Clean							
Spin	■						■
Rinse + Spin	■	■					■
Baby Care	■	■		■	■	■	■
Quick 15	■	■					■
Daily 39	■						■
Full Wash 60	■	■		■			■

1) Opsyen "Hygienic Care" boleh digabungkan dengan suhu pilihan 40 hingga 90 °C sahaja.



### 3.4 Opsyen

#### Pad Sentuh Laras Suhu (Temp)

Jika ingin pakaian dicuci pada suhu yang lain daripada yang diusulkan oleh mesin, tekan butang ini berulang kali untuk meningkatkan atau mengurangkan suhu.

#### Pad Sentuh Pilihan Kelajuan Putaran (Spin)

Tekan pad sentuh ini berulang kali untuk meningkatkan atau mengurangkan kelajuan putaran, jika anda ingin pakaian dicuci pada suhu yang lain daripada yang diusulkan oleh mesin pembasuh.



##### • Tiada Putaran ( )

Tiada opsyen putar yang menyingkirkan semua fasa putaran dan menambah bilangan bilasan.

##### • Tunda Bilasan ( )

Dengan memilih opsyen ini, air bilasan terakhir tidak dikosongkan dan dram berputar dengan kerap untuk mengelakkan kain basuhan daripada berkedut.



Pintu masih dikunci untuk menunjukkan bahawa semua air perlu dikeluarkan.

 Pintu tetap berkunci dengan air di dalam dram. Untuk meneruskan pusingan anda mesti menekan  (Start/ Pause).

#### Soak (Rendam)

Opsyen ini membolehkan anda merendam pakaian yang sangat kotor dan item dengan kesan yang bertanda pada permulaan basuhan sebelum fasa basuhan utama.

Opsyen ini akan meningkatkan tempoh masa program yang dipilih selama kira-kira 50 minit. Dan gunakan air lebih banyak daripada cucian biasa. Proses adalah seperti berikut.

 Tambahkan bahan pencuci untuk "Rendam" di petak "Prewash ".

1. Mengisi air dan pergerakan tab Cucian (Ambil masa kira-kira 20 min)

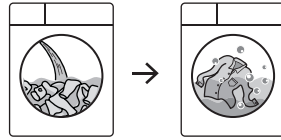

Selepas menekan butang Start/Pause mesin akan mula mengisi air ke dalam tab cucian, dimana ia akan mula berputar dengan perlahan untuk melarutkan bahan pencuci dan menyebarkan bahan pencuci ke atas pakaian dengan sama rata.

2. Merendam (Ambil masa kira-kira 30 min.)

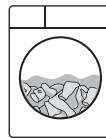

Mesin akan memasuki proses rendaman. Tab cucian akan berhenti dan berputar sekali-sekala untuk menyebarkan semula bahan pencuci ke atas pakaian.

3. Setelah proses rendaman selesai Mesin akan memeriksa paras air lagi dan akan memulakan program yang dipilih dan meneruskan dengan menggunakan udara rendaman yang sama.

#### **NOTA**

Jika anda tidak mahu menggunakan air rendaman tersebut bagi mencuci pakaian, sila ikuti langkah-langkah seperti dibawah:

1. Tekan Mula/Jeda untuk menjeda mesin basuh. Kemudian putar kenop program ke "Off" untuk mematikan mesin.
2. Tambah bahan pencuci, dan pilih program pilihan anda Tekan Start/Pause lagi untuk memulakan program yang dipilih.

Peranti akan mengesan dan membuang keluar air di dalam tangki secara automatik dan mengisi air sekali lagi untuk digunakan untuk mencuci.

**i** **NOTA**

- Sebarang suhu boleh dipilih tetapi air Dingin disyorkan dengan kitaran ini kerana air yang lebih panas boleh menyebabkan sedikit kesan yang bertanda.
- Gunakan jumlah detergen yang disyorkan untuk kitaran basuhan biasa. Jika mahu, gunakan peluntur atau agen rendaman yang selamat untuk fabrik dengan menuanginya ke dalam ruang detergen.

**Pad Sentuh Bilas Tambahan (Extra Rinse)**

Pergunaan pilihan ini disyorkan untuk orang yang alah kepada bahan sisa cucian dan di kawasan yang airnya amat lembut.

Pilih opsyen ini untuk menambah dua bilasan pada program. Penunjuk opsyen ini akan menyala.

**Pad Sentuh Prabasuh (Prewash)**

Pilih opsyen ini jika anda inginkan kain cucian anda diprabasuh sebelum basuhan utama. Gunakan pilihan ini untuk kotoran yang degil. Penunjuk opsyen ini akan menyala. Apabila anda menetapkan fungsi ini, masukkan detergen dalam ruang “**L**”.

Fungsi ini meningkatkan tempoh program.

**Pad Sentuh Tunda Akhir (Delay End)**

Sebelum anda memulakan program, opsyen ini membolehkan anda menentukan masa tamat program basuhan daripada minimum 1 jam hingga maksimum 20 jam.

**i** Jika tempoh program lebih lama daripada 3 jam, opsyen Tunda Akhir (Delay End) minimum bermula daripada 4 jam.

Tekan pad sentuh Tunda Akhir (Delay End) untuk memilih masa tamat seperti yang anda ingini. Paparan menunjukkan bilangan jam dan penunjuk di atas pad sentuh menyala.

**i** **Opsyen ini mesti dipilih selepas memilih program basuhan dan sebelum menekan pad sentuh “Start/Pause”.**

Sebagai contoh, jika tempoh program bagi program yang anda pilih ialah 3.20 jam dan anda menetapkan masa “Tunda Akhir” (Delay End) kepada 6 jam. Ini bermakna program basuhan anda akan tamat dalam masa 6 jam. (Lihat diagram di bawah)

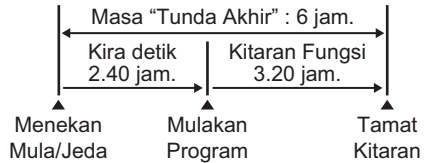

Selepas memilih masa Tunda Akhir (Delay End), tekan pad sentuh Mula/Jeda (Start/Pause) untuk memulakan program. Kemudian mesin akan mengira detik dan mengemaskinikan masa pada paparan setiap jam sehingga ia mencapai titik permulaan kitaran basuhan. Sekiranya anda mengubah atau membatalkan opsyen Tunda Akhir selepas memulakan program, ikuti langkah-langkah di bawah:

- tetapkan mesin basuh kepada JEDA dengan menekan pad sentuh;
- buang pilihan ini dengan menekan pad sentuh “Tunda Tamat” berulang kali sehingga paparan menunjukkan masa tunda “**00:01**”;
- tekan “Start/Pause” untuk memulakan program.

**Pad Sentuh Hygienic Care (wap) (☼)**

Pilih pilihan ini untuk menambah kira-kira 30 minit jatuh dalam wap selepas kitaran bilas. Petunjuk pilihan ini akan menyala.

**NOTA:**

- Wap mungkin tidak kelihatan di dalam dram semasa kitaran basuh wap. Wap akan membentuk di bawah dram dan dibiarkan meningkat secara semula jadi ke dalam pakaian.
- Wap mungkin tiada semasa keseluruhan kitaran basuh wap.
- Fungsi wap adalah lebih separuh penuh cekap dengan muatan.
- Di penghujung kitaran wap pakaian akan menjadi lebih hangat, lembut dan tertanggal dari dram.

 Jika opsyen wap dipilih, suhu bilas akan naik.

Semasa kitaran wap anda mungkin melihat wap keluar dari hos saluran mesin basuh, ini adalah biasa dan tidak perlu berasa cemas.



### 3.5 Tetapan



#### Ciri Keselamatan Kanak Kanak ( )

Perkakas anda disediakan dengan KUNCI KESELAMATAN KANAK-KANAK yang membenarkan anda untuk meninggalkan perkakas tidak dijaga dengan pintu ditutup tanpa perlu risau kanak-kanak mungkin tercedera atau menyebabkan kerosakan kepada perkakas.



 Tetapkan pilihan ini selepas menekan pad sentuh Mula/Jeda.

Untuk menetapkan pilihan “Kunci Keselamatan Kanak-kanak”:

- Untuk mengaktifkan fungsi ini, tekan dan tahan pad sentuh “Hygienic Care  ” selama lebih kurang 2 saat ikon “ ” akan ditunjukkan pada paparan disertai dengan bunyi pembaz.

 Jika anda menekan sebarang pad sentuh sewaktu Kunci Keselamatan Kanak-kanak diaktifkan, ikon “ ” akan berkelip 3 kali pada paparan disertai dengan bunyi pembaz.

 Pad sentuh dikunci.



- Untuk menyahaktifkan fungsi, tekan dan tahan pad sentuh “Hygienic Care  ” selama lebih kurang 2 saat ikon “ ” akan ditunjukkan pada paparan disertai dengan bunyi pembaz.

 Fungsi ini masih didayakan walaupun setelah perkakas dimatikan.

#### Mendayakan/Menyahdayakan Pembaz Tamat Basuhan

Tetapan ini membolehkan anda untuk mendayakan atau menyahdayakan pembaz apabila mesin program tamat. Sebagai contoh, anda mungkin mahu menyahdayakan pembaz ini apabila anda memulakan basuhan sewaktu masuk tidur, supaya apabila basuhan tamat kira-kira 1 jam kemudian, ia tidak akan mengganggu anda sepanjang malam.

 Bunyi bip amaran ralat, misalnya kerosakan kritikal, tidak dinyahdayakan.

- Untuk menyahdayakan bunyi pembaz, tekan pad sentuh “Temp” dan “Spin” secara serentak selama lebih kurang 3 saat, ikon “ ” akan ditunjukkan pada paparan disertai dengan bunyi pembaz.
- Untuk kembali ke konfigurasi lalai, tekan kedua-dua pad sentuh ini secara serentak selama lebih kurang 3 saat, ikon “ ” akan ditunjukkan pada paparan disertai dengan bunyi pembaz.

### 3.6 Pad sentuh Mula/Jeda (▷||) dan Tambah Pakaian (⇄)

Pad sentuh ini mempunyai 2 fungsi:

#### 1. Mula/Jeda (▷||)

Setelah anda memilih program dan pilihan yang diinginkan, tekan pad sentuh ini untuk memulakan mesin. Cahaya pandu Mula/Jeda akan berhenti berkelip dan kekal menyala sehingga paras air melebihi pinggir bawah pintu kemudian cahaya pandu akan PADAM. Jika anda telah membuat pilihan "Delay End", pengiraan detik akan dimulakan dan ditunjukkan pada paparan.

Untuk mengganggu program yang sedang berjalan, tekan pad sentuh ini untuk menjedakan mesin, cahaya pandu Mula/Jeda akan berkelip.

Untuk memulakan semula program dari takat ia diganggu, tekan pad sentuh ini sekali lagi, cahaya pandu Mula/Jeda akan berhenti berkelip.

#### 2. Tambah Pakaian (⇄)

**i** Anda hanya boleh menambah pakaian apabila ikon "⇄" dipaparkan pada paparan.

Untuk menambah pakaian:

1. Menekan pad sentuh "Mula/Jeda" untuk menjedakan program.
2. Tunggu mesin berhenti sepenuhnya sebelum membuka pintu (tunggu ikon kunci pintu "↔" dimatikan).
3. Tambah pakaian dan tutup pintu.
4. Sambung semula program dengan menekan pad sentuh "Mula/Jeda" sekali lagi.

---

## 4. SEBELUM PENGGUNAAN YANG PERTAMA

**i** Semasa pemasangan atau sebelum penggunaan pertama anda boleh melihat sedikit air di dalam mesin. Ini adalah air sisa yang tinggal dalam mesin selepas ujian yang berfungsi sepenuhnya di kilang untuk memastikan mesin itu diserahkan kepada pelanggan dalam keadaan yang sempurna dan tidak membimbangkan.

1. Pastikan sambungan elektrik dan air mematuhi arahan pemasangan.
2. Letakkan 2 liter air di dalam petak detergen untuk fasa basuhan. Ia mengaktifkan sistem salir.

3. Pilih kitar Cotton (Kapas) pada 90 °C, tanpa sebarang kain basuhan di dalam mesin, untuk mengeluarkan sebarang baki pengilangan dari dram dan tab kemudian mulakan mesin.

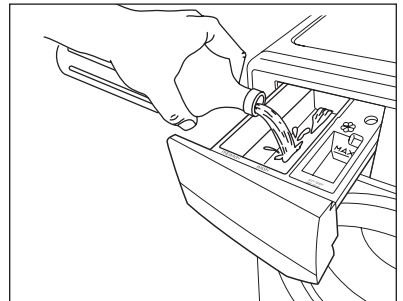

## 5. PENGGUNAAN HARIAN

### 5.1 Memuat Cucian

1. Buka bekalan arus air.
2. Pasangkan palam utama kepada soket utama.
3. Putar dail pemilih program kepada program yang dikehendaki.

Mesin basuh akan mengusulkan suhu dan secara automatik memilih nilai putaran maksimum yang diperuntukkan bagi program yang telah anda pilih. Tombol pemilih boleh diputar sama ada mengikut arah jam atau berlawanan arah jam.

4. Buka pintu dengan menarik pemegang pintu perlahan-lahan ke luar. Periksa dan keluarkan objek (jika ada) yang boleh tersekat di dalam lipatan.

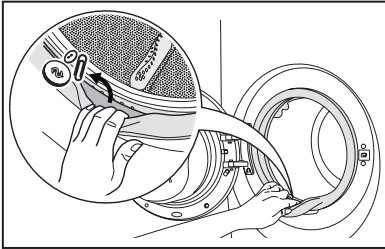

5. Masukkan pakaian ke dalam dram, satu persatu, sambil menggoncang-goncangkannya seberapa banyak yang mungkin. (Rujuk kepada muka surat 57 "PETUA MEMBASUH")
6. Tutup pintu muatan.

#### **!** AWAS!

Pastikan tiada kain cucian tertinggal diantara penutup dan pintu.

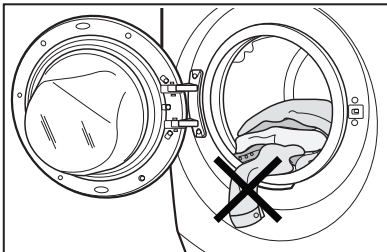

### 5.2 Mengguna Detergen dan Perapi Tambahan

**i** **PENTING:** Sila baca arahan bahan pencuci di muka surat 58 sebelum penggunaan.

1. Laci Dispenser Detergen

Dispenser Detergen dibahagikan kepada tiga ruang.

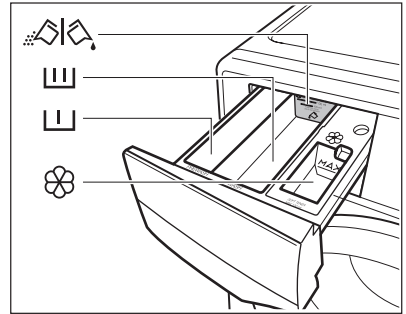

- **MAIN WASH**  
Ruang ini digunakan untuk detergen pada semua program.
- **PREWASH**  
Ruang ini hanya digunakan untuk detergen apabila Prabasuh dipilih.

#### **Detergent Kekap**

Flap untuk detergen serbuk atau cecair.

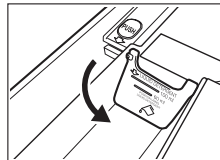

**Kedudukan bawah:** untuk detergen cecair.

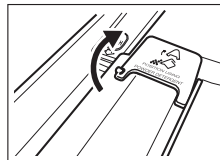

**Kedudukan atas:** untuk detergen serbuk.

- **SOFTENER**  
Ruang ini digunakan untuk perapi fabrik dan agen kanji.

**i** Apabila anda menggunakan detergen cecair:

- Jangan gunakan detergen cecair yang bergelatin atau pekat.
- Jangan letakkan cecair lebih banyak daripada paras maksimum.
- Jangan tetapkan fasa "Prewash".
- Jangan tetapkan "Delay End".

2. Sukat detergen dan pelembut pakaian;

- Tarik keluar petak dispenser sehingga ia berhenti.
- Ukur sukatan detergen yang diperlukan, tuang ia ke dalam tempat basuhan utama "III".
- Jika anda mahu melakukan fasa "Prewash", tuangkannya ke dalam ruang yang bertanda "II".

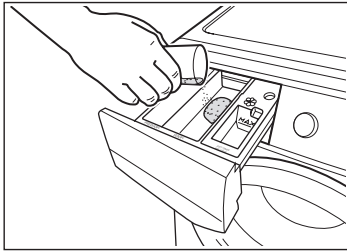

- Jika perlu, tuangkan pelembut fabrik ke dalam bekas bertanda "☼".

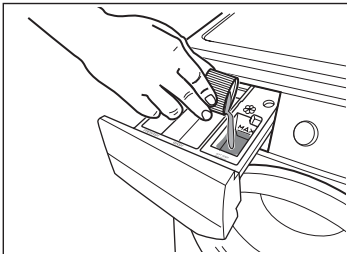

**i** NOTA

Jumlah yang digunakan mesti tidak melebihi tanda "MAX" di dalam petak. Jika anda menggunakan pelembut pekat, disarankan agar mencairkannya dengan air dahulu.

- Tutup laci perlahan-lahan.

**i** NOTA

Selepas kitaran cucian selesai, sisa detergen, pelembut dan air mungkin berada di dalam kotak pendispens. Adalah disyorkan agar kotak pendispens dibersihkan dengan kerap untuk mengeluarkan sebarang sisa.

### 5.3 Tetapan Opsyen

1. Jika anda mahu cucian anda diputar atau gunakan suhu berlainan daripada yang disarankan oleh mesin basuh, tekan pad sentuh Putar "Spin" dan suhu "Temp" berulang kali untuk menukar kelajuan dan suhu putaran.

Pilih dan tekan opsyen pad sentuh, jika anda inginkan kain basuhan anda dicitri dengan fungsi khas.

**i** NOTA

- Fungsi berlainan boleh digabungkan yang bergantung pada program yang dipilih.
- Jika anda membuat pilihan yang tidak serasi dengan program basuhan yang disetkan, mesej " --- " akan berkelip dan bunyi bip kedengaran.

2. Jika anda mahu menundakan permulaan program pembasuhan, tekan pad sentuh "Delay End" berulang kali untuk memilih masa tunda mesin basuh anda.

## 5.4 Memula Program (▷||)

Untuk memulakan program, tekan pad sentuh Start/Pause (▷||), lampu panduan yang berkaitan akan berhenti berkelip dan tempoh program akan dipaparkan pada skrin.

Selepas kira-kira 15 minit dari permulaan program:

- Perkakas akan melaras secara automatik tempoh program yang dipilih mengikut jenis dan saiz muatan.
- Paparan akan menunjukkan tempoh program yang dilaras.

### **NOTA**

Jika anda menekan sebarang pad sentuh sewaktu program sedang beroperasi, paparan akan menunjukkan mesej “ --- ”.

## 5.5 Gangguan Program

- Untuk menjeda tekan Start/Pause. Penunjuk akan mula berkelip.
- Tekan Start/Pause sekali lagi. Program akan diteruskan.

## 5.6 Menukar Program

Menukar program yang sedang berjalan hanya boleh dilakukan dengan mematikan suis perkakas.

- Putar tombol pemilih program ke kedudukan “Off” untuk membatalkan program dan matikan perkakas.
- Putar tombol pemilih program ke kedudukan program baru dan tetakkan opsyen baru, kemudian, tekan pad sentuh “Start/Pause” (Mula/Jeda) sekali lagi.

 Perkakas tidak akan mengeluarkan air. (kecuali program; Spin, Rinse + Spin, Tub Clean).

## 5.7 Menukar Opsyen

Selepas program bermula, hanya beberapa opsyen boleh ditukarkan.

1. Tekan pad sentuh “Start/Pause”. Penunjuk akan mula berkelip.
2. Pilih dan tukar opsyen.
3. Tekan “Start/Pause” sekali lagi. Program akan diteruskan.

## 5.8 Membuka Pintu



Semasa program atau “Delay End” sedang beroperasi, pintu perkakas akan dikunci dan paparan menunjukkan penunjuk “”. Tetapkan mesin basuh ke PAUSE (JEDA) dengan menekan pad sentuh “Start/Pause” (Mula/Jeda). Tunggu sehingga penunjuk kunci pintu padam, barulah pintu boleh dibuka.

Jika penunjuk kunci pintu “” tidak padam, ini bermakna mesin sudah mula memanaskan dan paras air berada di atas hujung bawah pintu atau dram sedang berputar. Dalam hal ini pintu TIDAK BOLEH dibuka. Jika anda perlu membukanya, anda perlu mengalirkan air untuk membuka pintu.



**Jika ia adalah satu kes kecemasan yang perlu membuka pintu serta-merta. Sila baca “Membuka Pintu Mesin Semasa Kecemasan” pada halaman 66.**

## 5.9 Di Penghujung Program

- Perkakas berhenti secara automatik.
- Isyarat akustik akan beroperasi.
- Paparan akan menunjukkan “”.
- Penunjuk pad sentuh Start/Pause (Mula/Jeda) padam.
- Penunjuk kunci pintu “” padam.
- Keluarkan pakaian daripada perkakas. Pastikan dram dikosongkan.
- Biarkan pintu terbuka, untuk mengelakkan kulat dan bau.
- Tutup pili air.

### **i** NOTA

Di penghujung program, baki masa boleh menurun secara tiba-tiba daripada 7 minit atau kurang kepada 0 kerana terlebih anggaran masa semasa fasa penderiaan muatan. Dalam sesetengah kes, (muatan seimbang) masa program boleh menjadi lebih pendek daripada masa yang dianggarkan selepas fasa penderiaan muatan selesai. Perkara begini biasa berlaku pada mesin dan bukan sesuatu yang perlu dibimbangkan kerana ini tidak mengganggu prestasi.



## 5.10 Apabila Program Membasuh Selesai, Tetapi Terdapat Air Di Dalam Dram

(Penggunaan Pilihan “Rinse Hold”)

- Dram berputar secara kerap untuk mengelakkan renyuk pada pakaian.
- Penunjuk “Mula/Jeda” berkelip untuk mengingatkan anda untuk mengalirkan air.
- Penunjuk pintu kunci “ ” dihidupkan. Pintu akan tetap dikunci.

Anda mesti mengeringkan air untuk membuka pintu.

### Untuk menyalurkan air:

1. Tekan pad sentuh “Mula/Jeda  ”. Perkakas menyalurkan air dan memutar pada kelajuan putaran maksimum bagi program yang dipilih. Secara alternatif, sebelum menekan pad sentuh “Mula/Jeda”, anda boleh menekan pad sentuh “Spin” untuk menukar kelajuan putaran. Anda boleh memilih “No Spin ( )”, jika anda mahu mesin menyalurkan air sahaja, kemudian tekan pad sentuh Mula/Jeda. Perkakas akan menyalurkan air dan memutar.
2. Apabila program selesai dan penunjuk pintu kunci “ ” padam, anda boleh membuka pintu.
3. Putar tombol pemilih program ke kedudukan “Off” untuk menyahaktifkan perkakas.

### **i** NOTA

Selepas lebih kurang 18 jam jika anda tidak menekan pad sentuh Mula/Jeda, perkakas akan menyalurkan air dan memutar secara automatik.

## 5.11 AUTO Off Mod

5 minit selepas program membasuh tamat, jika anda tidak menyahaktifkan perkakas, fungsi penjimatan tenaga diaktifkan.

Fungsi penjimatan tenaga mengurangkan penggunaan tenaga apabila perkakas dalam mod siap sedia.

- Semua penunjuk dan paparan akan dimatikan.
- Penunjuk pad sentuh Start/Pause (Mula/Jeda) akan berkelip perlahan.
- Tekan satu daripada pad sentuh untuk menyahaktifkan status penjimatan tenaga.



## 6. PETUA MEMBASUH

### 6.1 Mengasing Pakaian

Ikut simbol kod cucian pada setiap label pakaian dan arahan cucian pengilang. Asingkan pakaian seperti berikut: putih, berwarna, sintetik, bahan halus, bahan wul.

### 6.2 Suhu

90°C	Bagi kain kapas dan linen dengan kotoran biasa (cth. alas meja teh, tuala, alas meja, cadar...).
60°C 50°C	Bagi kotoran biasa, pakaian mudah luntur (cth. kemeja, baju tidur, pijama....) daripada linen, kapas atau gentian sintetik dan untuk kain kapas yang ringan kotoran (cth. pakaian dalam).
40°C 30°C Sejuk	Bagi item halus (cth. langsir net), pakaian bercampur termasuk gentian sintetik dan wul dengan label "wul baru tulen, boleh dibasuh mesin, tidak mengecut".

### 6.3 Sebelum Memuat Pakaian

- Pastikan tiada objek logam tertinggal di dalam pakaian (cth. klip rambut, pin keselamatan, jarum).

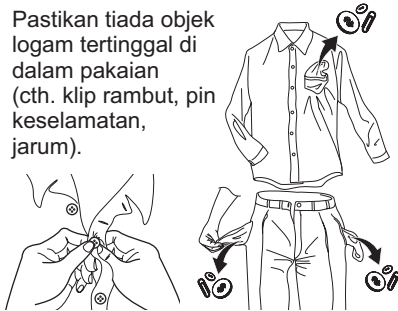

- Butangkan sarung bantal, tutup zip, cangkuk dan butang ketap. Ikatkan sebarang tali pinggang atau pita yang panjang.

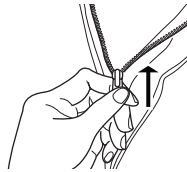

- Cuci coli, sarung kaki dan pakaian lembut lain di dalam beg cucian yang boleh anda beli di pasaraya.



- Pastikan anda mencuci pengumpul lin secara berasingan daripada pengeluar lin.
- Jangan basuh pakaian putih dan berwarna bersama-sama. Pakaian putih boleh kehilangan "keputihannya" dalam cucian.
- Pakaian berwarna yang baru mungkin luntur dalam basuhan pertama; maka ia perlu dibasuh berasingan pada kali pertama.
- Tanggalkan tanda kotoran degil sebelum membasuh.
- Bahagian yang sangat kotor hendaklah digosokkan dengan detergen khas atau pes detergen. Langsir hendaklah diperlakukan dengan cermat. Tanggalkan cangkuk atau ikatkannya di dalam beg atau jaring.

### 6.4 Muatan Maksimum

Beban maksimum yang disarankan dinyatakan di dalam carta program (lihat halaman 46).

Peraturan umum:

Kapas, linen:	dram penuh tetapi tidak terlalu padat;
Sintetik:	dram tidak lebih daripada separuh penuh;
Bahan halus dan wul:	dram tidak lebih daripada sepertiga penuh.

Membasuh pakaian dengan beban maksimum menghasilkan penggunaan air dan tenaga yang paling cekap. Bagi pakaian yang sangat kotor, kurangkan saiz muatan.

### 6.5 Menanggal Kotoran

Tanda kotoran degil mungkin tidak dapat ditanggalkan hanya dengan air dan detergen. Oleh itu, adalah dinasihatkan untuk merawatnya terlebih dahulu sebelum membasuh.

**Darah:** bersihkan kotoran yang masih baru dengan air sejuk. Untuk kotoran kering, rendam semalaman di dalam air dengan detergen khas kemudian gosok dengan sabun dan air.

**Cat berasaskan minyak:** lembapkan dengan penghapus kotoran benzin, bentangkan pakaian di atas kain lembut dan padapkan kotoran tersebut; bersihkan beberapa kali.

**Kotoran gris kering:** lembapkan dengan turpentin, bentangkan pakaian tersebut di atas permukaan yang lembut dan padapkan tanda kotoran dengan hujung jari dan sehelai kain kapas.

**Karat:** asid oksalik dilarutkan dalam air panas atau produk penghapus karat digunakan dalam air sejuk. Berhati-hati dengan tanda karat yang sudah lama kerana struktur selulosanya telah rosak dan pakaian mudah berlubang.

**Kotoran kulit:** bersihkan dengan peluntur, bilas dengan betul(kain putih dan kain berwarna tahan luntur sahaja).

**Rumput:** letak sedikit sabun dan bersihkan dengan peluntur (kain putih dan kain berwarna tahan luntur sahaja).

**Pena mata bola dan gam:** lembapkan dengan aseton(\*), bentangkan di atas kain lembut dan padapkan tanda kotoran itu.

**Gincu:** lembapkan dengan aseton (\*) seperti di atas, kemudian bersihkan kotoran dengan spirit bermetil. Hapuskan sisa tanda daripada kain putih dengan peluntur.

**Wain merah:** rendam dalam air dan detergen, bilas dan bersihkan dengan asid asetik atau sitrik, kemudian bilas. Bersihkan sebarang tanda sisa dengan peluntur.

**Dakwat:** bergantung pada jenis dakwat, lembapkan pakaian dahulu dengan aseton (\*), kemudian dengan asid asetik; bersihkan sebarang tanda sisa pada pakaian putih dengan peluntur dan kemudian bilas dengan bersih.

**Kotoran tar:** bersihkan dahulu dengan penghapus kotoran, spirit bermetil atau benzin, kemudian gosokkannya dengan pes detergen.

(\* ) jangan gunakan aseton pada sutera buatan.

## 6.6 Jenis Bahan Pencuci dan Kuantiti Bahan Pencuci

Detergen kurang buih diperlukan untuk mesin basuh ini bagi mencegah masalah buih yang terlalu banyak, hasil basuhan yang tidak memuaskan hati dan kemudaratan terhadap mesin.

Detergen kurang buih yang dihasilkan untuk mesin basuh muatan depan dilabelkan sebagai "Muatan Depan", "kecekapan tinggi", "HE", misalnya Kuasa Sejuk untuk Pemuat Depan atau "Matic".

**Jangan gunakan jenis detergen yang salah misalnya Muatan Atas, detergen Basuhan Tangan atau produk Berasaskan Sabun di dalam mesin basuh muatan depan. Ini boleh menghasilkan buih sabun yang terlalu banyak, masa kitaran yang lebih lama, kelajuan putaran yang rendah, bilasan yang lemah dan menyebabkan motor menampung bebanan yang berlebihan.**

### Kuantiti bahan pencuci untuk digunakan

Pilihan bahan pencuci dan penggunaan kuantiti yang betul bukan sahaja memberi kesan kepada prestasi cucian anda, malah membantu mengelakkan pembaziran dan melindungi persekitaran.

Walaupun boleh diuraikan melalui tindakan biologi, bahan pencuci mengandungi bahan-bahan dimana, dalam kuantiti yang banyak, boleh merosakkan keseimbangan halus alam sekitar.

### Pilihan dan kuantiti bahan pencuci bergantung kepada ;

- jenis fabrik (halus, bulu, kapas, dan lain-lain.) ;
- warna pakaian;
- saiz muatan;
- tahap kotoran;
- suhu cucian; dan
- kekuatan air yang digunakan.

Kekerasan air dikelaskan mengikut "tahap" kekerasan.

Maklumat tentang kekerasan air dalam kawasan anda boleh diperolehi daripada syarikat bekalan air yang berkaitan, atau dari pihak berkuasa tempatan anda.

Anda mungkin perlu mencuba menggunakan kuantiti bahan pencuci mengikut setiap arahan pengeluar produk kemudian bandingkan hasil cucian dengan senarai di bawah dan sesuaikan jumlah bahan pencuci untuk masa akan datang dengan sewajarnya.

**Serbuk pencuci yang tidak mencukupi menyebabkan:**

- muatan cucian bertukar menjadi kelabu,
- pakaian berminyak.

**Serbuk pencuci yang terlalu banyak menyebabkan:**

































- berbuih-buih,
- kesan cucian berkurang,
- pembilasan kurang baik

**Kurangkan bahan pencuci jika:**

- anda mencuci muatan yang sedikit,
- cucian tidak begitu kotor
- jumlah buih yang banyak semasa mencuci.

## 7. SIMBOL KOD BASUH ANTARABANGSA

 Simbol ini terdapat pada label pakaian, untuk membantu anda memilih cara terbaik membersihkan cucian anda.

 <b>Cucian bertenaga</b>	 Suhu maksimum cucian 95 °C	 Suhu maksimum cucian 60 °C	 Suhu maksimum cucian 40 °C	 Suhu maksimum cucian 30 °C	 Cucian tangan	 JANGAN cuci
 <b>Cucian lembut</b>			 			
 <b>Meluntur</b>	 Meluntur dalam air sejuk			 JANGAN meluntur		
 <b>Menyeterika</b>	 Seterika panas maks. 200 °C	 Seterika hangat maks. 150 °C	 Seterika suam maks. 110 °C	 JANGAN seterika		
 <b>Cucian kering</b>	 Cucian kering dalam semua pelarut	 Cucian kering dalam perkloritena, petrol, alkohol tulen, R 111 & R 113		 Cucian kering dalam petrol, alkohol tulen dan R 113		 JANGAN cuci kering
 <b>Mengering</b>	 Bentangkan	 Di ampaijan	 Penyidai pakaian	 Suhu tinggi  Suhu rendah Mesin pengering		 JANGAN gunakan mesin pengering

## 8. PENJAGAAN DAN PEMBERSIHAN

**!** **AMARAN!** Anda mesti MEMUTUSKAN **SAMBUNGAN** bekalan elektrik daripada perkakas, sebelum anda boleh menjalankan pembersihan atau kerja penyelenggaraan.

### 8.1 Pembersihan Luar

Bersihkan perkakas hanya dengan sabun dan air suam. Keringkan semua permukaan sepenuhnya.

**!** **AWAS!** Jangan gunakan alkohol, pelarut atau produk bahan kimia.

### 8.2 Menanggalkan Kesan Kapur

Air yang biasa kita gunakan mengandungi kapur. Adalah menjadi idea yang baik untuk kadang kala menggunakan serbuk pelembut air dalam mesin.

Lakukan ini secara berasingan daripada cucian pakaian, dan mengikut arahanserbuk pelembut yang dikeluarkan oleh kilang. Ini akan membantu mencegah pembentukan deposit kapur.

### 8.3 Selepas Setiap Cucian

Biarkan pintu terbuka sebentar. Ini membantu mencegah kulat dan bau lembap yang terbentuk di dalam perkakas. Membiarkan pintu terbuka selepas pembasuhan juga akan membantu memelihara kedap pintu.

### 8.4 Basuhan Penyelenggaraan Dengan Program “Tub Clean”

Dengan penggunaan pembasuhan suhu rendah, ada kemungkinan sisa termendap di dalam dram. Kami mengesyorkan agar program “Pembersihan Tab” digunakan secara tetap untuk membuang sebarang sisa.

**Untuk menjalankan basuhan penyelenggaraan:**

- Dram hendaklah kosong daripada kain kotor.
- Pilih program “Tub Clean”.
- Tekan Mula/Jeda untuk memulakan program.

### 8.5 Membersih Petak Dispenser

Petak dispenser serbuk cucian dan perapi tambahan harus kerap dibersihkan. Keluarkan petak dengan menekan selak ke bawah dan teriknya keluar.

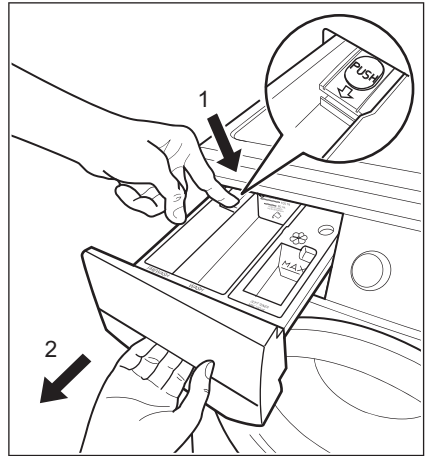

Untuk memudahkan pembersihan, bahagian atas petak perapi tambahan harus dikeluarkan.

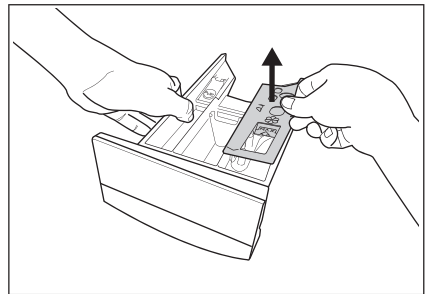

Bersihkan dengan air paip, untuk membuang kesan serbuk yang terkumpul.

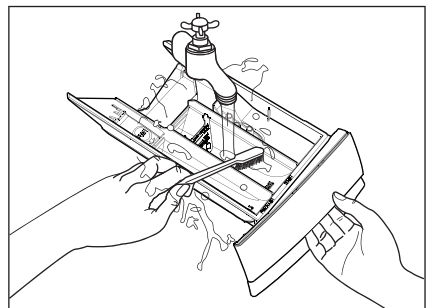

## 8.6 Membersih Ceruk Petak

Selepas petak dikeluarkan, gunakan berus kecil untuk membersihkan bahagian ceruk, pastikan semua sisa serbuk cucian dibuang dari atas dan bawah ceruk. Letak semula petak dan jalankan program bilas tanpa sebarang pakaian di dalam dram.

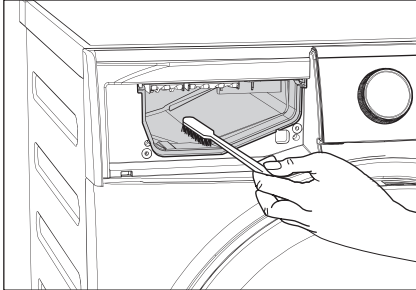

## 8.7 Membersih Penapis Aliran Air Masuk

Jika air anda keras atau mengandungi kesan deposit kapur, penapis aliran air masuk mungkin tersumbat. Oleh itu idea yang baik ialah membersihkannya dari masa ke semasa.

**Untuk membersihkan penapis aliran air masuk:**

1. Tutup pili air.
2. Keluarkan hos aliran air masuk daripada pili air.
3. Bersihkan penuras dalam hos dengan berus keras.

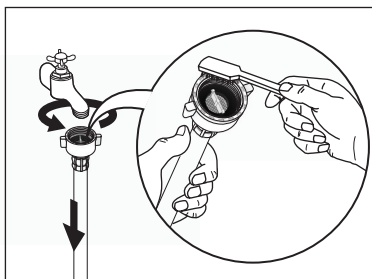

4. Keluarkan hos aliran air masuk di belakang perkakas.

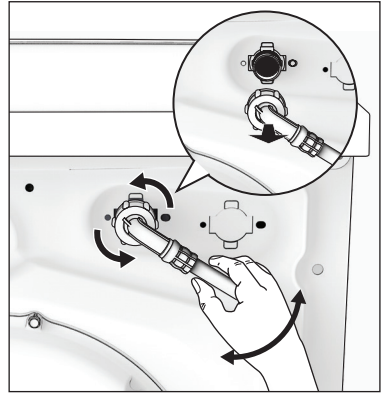

5. Bersihkan penapis di dalam injap dengan berus kasar atau tuala.

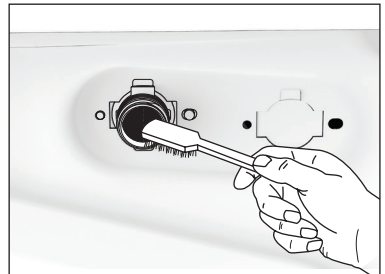

6. Pasangkan semula hos aliran air masuk. Pastikan sambungan ketat untuk mengelak kebocoran.
7. Buka pili air.

## 8.8 Langkah Berwaspada Fros

Jika perkakas dipasang di tempat yang suhunya boleh turun sehingga kurang daripada 0 °C, buang baki air di dalam hos salur masuk dan pam saliran.

### Saliran Kecemasan

1. Tanggalkan palam sesalur daripada soket sesalur. Tutup pili air.
2. Tanggalkan hos salur masuk air.
3. Tanggalkan hos salir dari sokongan belakang dan cabut pencangkuk dari sink atau spigot.

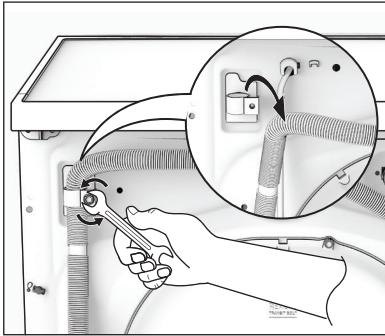

4. Letakkan hujung salir dan hos saluran masuk di dalam bekas. Biarkan air menyalir keluar daripada hos.

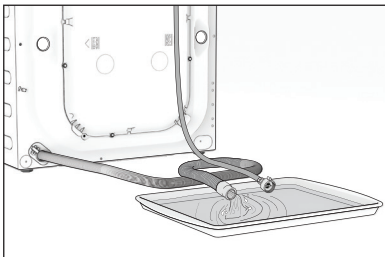

5. Apabila tiada lagi air mengalir, pasang hos saluran masuk dan hos salir sekali lagi.

### **NOTA**

Pastikan suhu-lebih daripada 0 °C sebelum anda menggunakan semula perkakas.

## 9. PENYELESAIAN MASALAH

### 9.1 Kegagalan Kemungkinan

Sesetengah masalah tertentu adalah berpunca daripada kurang penyelenggaraan yang mudah atau kesilapan yang boleh diselesaikan dengan mudah tanpa menghubungi jurutera. Sebelum menghubungi Pusat Servis tempatan anda, sila jalankan pemeriksaan yang disenaraikan di bawah.

Setelah masalah tersebut diselesaikan, tekan butang "START/PAUSE" untuk memulakan semula program. Jika masalah masih berlarutan setelah semua sudah diperiksa, hubungi Pusat Servis tempatan anda.



**AWAS!** Nyahaktifkan perkakas sebelum anda melakukan cek.

#### Kod Penggera:

<b>E10</b>	Mesin tidak mengisi air.
<b>E20</b>	Mesin tidak menyalir air.
<b>E40</b>	Pintu tidak ditutup atau pintu tidak ditutup dengan betul. Sila semak pintu!
<b>E40</b>	Bekalan kuasa utama tidak stabil. Tunggu sehingga bekalan kuasa utama stabil kembali dan mesin akan bermula operasi secara automatik.
<b>E91</b>	Tiada komunikasi antara elemen elektronik pada perkakas. Matikan dan hidupkan semula.

Malfungsi	Kemungkinan Punca	Penyelesaian
<b>Mesin basuh tidak boleh dimulakan:</b>	Pintu tidak ditutup. (Kod ralat: E40)	Tutup pintu dengan rapi.
	Plag tidak dimasukkan dengan betul ke dalam soket kuasa.	Masukkan plag ke dalam soket kuasa.
	Tiada bekalan kuasa di soket.	Sila periksa pemasangan elektrik domestik anda.
	Butang Start/Pause tidak ditekan.	Tekan butang Start/Pause.
	Delay End (☺) telah dipilih.	Jika pakaian mahu dicuci segera, batalkan "Delay End".
	Bekalan Utama tidak stabil. (Jika E40 muncul pada paparan.)	Tunggu hingga bekalan utama stabil. Perkakas akan dimulakan secara automatik.
<b>Mesin tidak mengisi air:</b>	Pili air tertutup. (Kod ralat: E10)	Buka pili air.
	Hos air masuk tertindih atau terpiuh. (Kod ralat: E10)	Periksa sambungan hos air masuk.
	Penuras dalam hos air masuk tersumbat. (Kod ralat: E10)	Bersihkan penuras hos air masuk.
	Pintu tidak ditutup dengan betul. (Kod ralat: E40)	Tutup pintu dengan rapi.
<b>Mesin mengisi kemudian terus menyalirkan:</b>	Hujung hos saliran terlalu rendah. (Kod ralat: E10)	Sila rujuk perenggan berkenaan di bahagian "Penyaliran Air".

<b>Malfungsi</b>	<b>Kemungkinan Punca</b>	<b>Penyelesaian</b>
<b>Mesin tidak menyalirkan air dan/atau tidak memutar:</b>	Hos saliran tertindih atau terpiuh. (Kod ralat: E20)	Periksa sambungan hos penyaliran.
	Pam saliran tersumbat. (Kod ralat: E20)	Bersihkan penuras saliran.
	Opsyen "Rinse Hold" telah dipilih.	Tekan Mula/Jeda untuk mengalirkan air, atau Pilih program putaran (Spin).
	Pakaian tidak diagihkan sama rata di dalam dram.	Jeda mesin dan agihkan semula pakaian secara manual.
<b>Terdapat air di atas lantai:</b>	Terlalu banyak detergen atau detergen tidak sesuai digunakan (mengeluarkan terlalu banyak buih).	Kurangkan kuantiti detergen atau gunakan yang lain. (Lihat halaman 58)
	Periksa sama ada terdapat kebocoran dari salah satu pemasangan hos air masuk. Kebocoran itu kadang tala sukar dilihat kerana air mengalir hos; periksa sama ada hos itu lembap.	Periksa sambungan hos air masuk.
	Hos saliran rosak.	Hubungi pusat perkhidmatan kami.
<b>Hasil cucian yang tidak memuaskan:</b>	Detergen tidak mencukupi atau tidak sesuai untuk digunakan.	Tingkatkan kuantiti detergen atau gunakan yang lain. (Lihat halaman 58)
	Tanda kotoran degil tidak dibersihkan terlebih dahulu sebelum membasuh.	Gunakan produk komersil untuk merawat kesan kotoran yang degil.
	Suhu yang betul tidak dipilih.	Periksa sama ada anda telah memilih suhu yang betul.
	Muatan pakaian berlebihan.	Kurangkan muatan.
<b>Pintu tidak dapat dibuka:</b>	Program masih berjalan.	Tunggu sehingga putaran basuhan terakhir.
	Terdapat air di dalam dram.	Anda hendaklah menyalirkan air untuk membuka pintu (rujuk "Membuka Pintu" pada muka surat 55).
	Masalah ini mungkin disebabkan oleh kegagalan fungsi mesin basuh.	Sila hubungi Talian Khidmat Pelanggan kami. Jika anda perlu buka pintu mesin, sila baca perenggan "Membuka Pintu Mesin Semasa Kecemasan" (lihat halaman 66).



<b>Malfungsi</b>	<b>Kemungkinan Punca</b>	<b>Penyelesaian</b>
<b>Mesin bergegar atau bunyinya bising:</b>	Bolt pengangkutan dan pembungkusan belum dikeluarkan.	Periksa supaya pemasangan perkakas dibuat dengan betul.
	Kaki penyokong belum dilaraskan lagi.	Periksa supaya pengarasan perkakas dibuat dengan betul.
	Pakaian tidak diagihkan sama rata di dalam dram.	Jeda mesin dan agihkan semula pakaian secara manual.
	Jumlah pakaian di dalam dram terlalu sedikit.	Muatkan lebih banyak pakaian.
	Lantai tidak stabil cth. lantai kayu.	Rujuk perenggan berkenaan dalam bahagian "Pemasangan".
<b>Masa kitaran lebih lama daripada yang dipaparkan:</b>	Detergen melebihi dos.	Kurangkan kuantiti detergen atau gunakan yang lain. (Lihat halaman 58)
	Mesin tidak seimbang.	Agihkan semula pakaian secara manual di dalam dram dan mulakan fasa putaran sekali lagi.
<b>Kitaran ini adalah lebih pendek daripada masa yang dipaparkan.</b>	Perkakas mengira masa yang baru mengikut beban pakaian.	
<b>Putaran bermula lambat atau mesin tidak berputar:</b>	Peranti pengesan ketidakseimbangan elektronik telah menyela kerana pakaian tidak diagihkan sama rata di dalam dram. Pakaian diagihkan semula melalui putaran balikan dram. Hal ini mungkin berlaku beberapa kali sebelum ketidakseimbangan hilang dan pemutaran normal dapat disambungkan semula. Jika, selepas 10 minit, pakaian masih belum diagihkan sama rata di dalam dram, mesin tidak akan berputar. Dalam kes sebegini, sebarkan semula muatan secara manual dan pilih program putar.	Jeda mesin dan agihkan semula pakaian secara manual.
<b>Mesin mengeluarkan bunyi pelik:</b>	Mesin tidak dipasang dengan betul.	Pastikan peletakan aras perkakas adalah betul. Rujuk pada "Pemasangan".
	Bolt atau bungkusan transit tidak dikeluarkan.	Pastikan bungkusan dan/atau bolt transit dikeluarkan. Rujuk pada "Mengeluarkan".
	Muatan terlalu kecil.	Tambah lebih banyak pakaian ke dalam dram.
<b>Tiada air kelihatan di dalam dram:</b>	Mesin yang berasaskan teknologi moden beroperasi secara sangat ekonomik dengan menggunakan jumlah air yang sangat sedikit tanpa menjejaskan prestasi.	

### **i** NOTA

Jika anda tidak dapat mengenal pasti atau menyelesaikan masalah, hubungi pusat perkhidmatan kami. Sebelum menghubungi kami, catat model, nombor siri dan tarikh pembelian mesin anda: Pusat Perkhidmatan akan memerlukan maklumat ini.

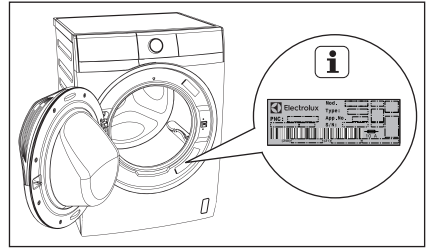

## 9.2 Membuka Pintu Mesin Semasa Kecemasan

Pada masa kecemasan apabila mesin mengalami kegagalan fungsi dan pintu dikunci. Mesin akan meneruskan program basuh apabila bekalan elektrik kembali. Jika pintu dikunci disebabkan oleh kegagalan fungsi mesin, pintu boleh dibuka dengan pembukaan pintu semasa kecemasan.

**Sebelum pintu dibukakan:**

### **!** Amaran!

**Pastikan suhu air dan pakaian di dalam mesin tidak panas. Sila tunggu sehingga suhu air dingin.**

**Pastikan paras air di dalam tab basuh tidak tinggi. Sila buat pengaliran air kecemasan. (rujuk kepada "Saliran Kecemasan" pada halaman 62)**

**Pastikan tab basuh tidak berputar. Tunggu sehingga tab basuh berhenti.**

**Untuk membuka pintu semasa kecemasan, sila:**

1. Tekan "Hidup / Mati" untuk mematikan perkakas. Tanggalkan palam utama dari soket utama.
2. Mengeluarkan pintu penutup, seperti gambar di bawah.
3. Tarik kunci kecemasan untuk membuka ke bawah kemudian buka pintu perkakas.
4. Ambil pakaian.
5. Pasang kembali pintu penutup.

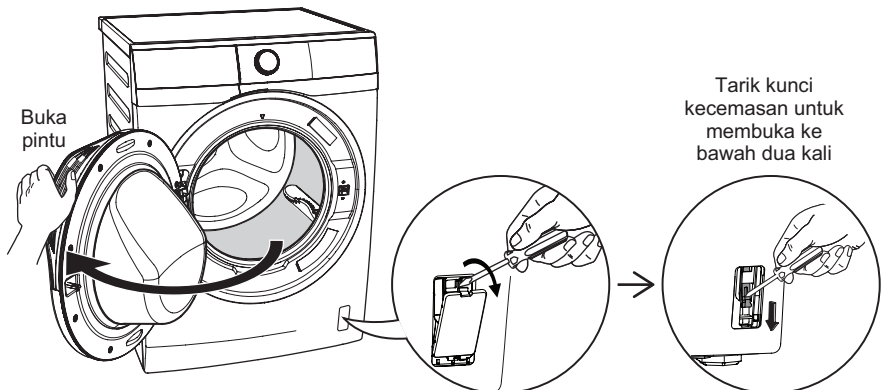

## 10. DATA TEKNIKAL

<b>Dimensi (Tinggi / Lebar / Dalam)</b>	EWF7524D3WB / EWF8024D3WB : 848 x 596.5 x 567.5 mm EWF9024D3WB : 848 x 596.5 x 659.0 mm		
<b>Bekalan kuasa (Voltan / Frekuensi)</b>	220-240 V~ / 50 Hz		
<b>Jumlah kuasa</b>	2000 W		
<b>Perlindungan fuis minimum</b>	10 A		
<b>Tekanan bekalan air (Maksimum / Minimum)</b>	0.8 MPa / 0.05 MPa		
<b>Beban Maksimum (pakaian kering)</b>	<b>Program</b>	EWF7524D3WB EWF8024D3WB	EWF9024D3WB
	<b>Off</b>	-	-
	<b>Cottons</b>	<b>Max.<sup>1)</sup></b>	<b>Max.<sup>1)</sup></b>
	<b>Mixed</b>	4 kg	4 kg
	<b>Delicates</b>	4 kg	4 kg
	<b>Bedding</b>	3 kg	3 kg
	<b>Energy Saver</b>	<b>Max.</b>	<b>Max.</b>
	<b>Tub Clean</b>	-	-
	<b>Spin</b>	<b>Max.</b>	<b>Max.</b>
	<b>Rinse + Spin</b>	<b>Max.</b>	<b>Max.</b>
	<b>Baby Care</b>	4 kg	4 kg
	<b>Quick 15</b>	1.5 kg	1.5 kg
	<b>Daily 39</b>	4 kg	5 kg
<b>Full Wash 60 Favourite</b>	<b>Max.</b>	<b>Max.</b>	
<b>Favourite</b>	-	-	
<b>Kelajuan putaran (Maksimum / Minimum)</b>	1200 rpm / 400 rpm		

1) Kapasiti maksimum tergantung pada model Mesin Cuci (lihat ditentukan di panel kontrol)

## 11. PEMASANGAN

### 11.1 Mengeluarkan

#### **AWAS!**

Semua bolt pengangkutan dan bahan pembungkusan mesti dikeluarkan sebelum menggunakan perkakas. Anda dinasihatkan supaya menyimpan semua peranti pengangkutan supaya dapat dipasang semula jika mesin perlu diangkut lagi nanti.

- Gunakan sarung tangan. Potong dan keluarkan empat memotong tali seperti yang ditunjukkan.

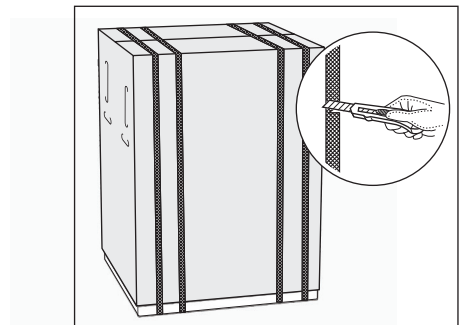

2. Buang kotak karton. Tanggalkan bahan bungkus polisterin. Tanggalkan beg plastik yang menutup mesin.

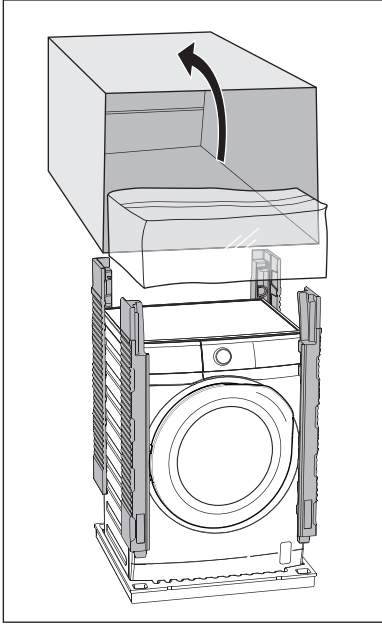

3. Buka pintu. Keluarkan kepingan polistren daripada pengedap pintu dan semua barang dari dram.

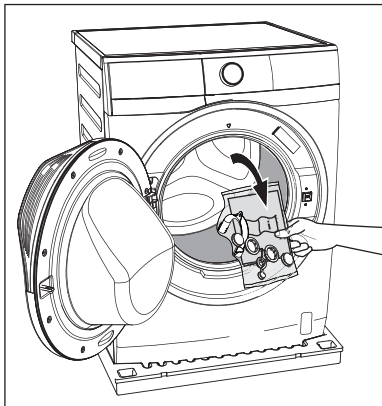

4. Letakkan salah satu elemen bungkus polisterin di atas lantai di belakang perkakas. Dengan berhati-hati letakkan perkakas dengan bahagian belakang di atasnya. Pastikan tidak merosakkan hos.

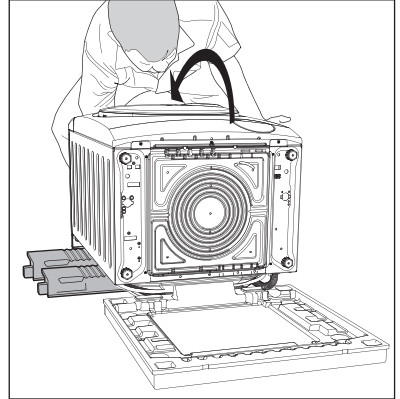

5. Tanggalkan dasar polisterin.

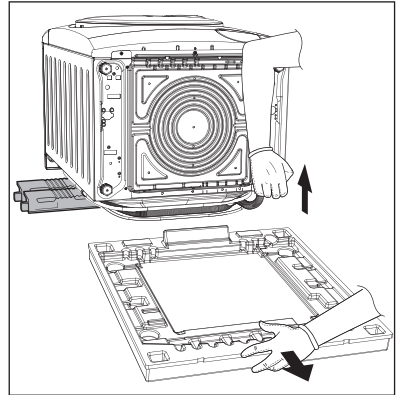

6. Tarik perkakas dalam kedudukan menegak.position.
7. Keluarkan kabel bekalan kuasa dan hos saliran dan air masuk daripada pemegang hos (A) pada bahagian belakang perkakas.

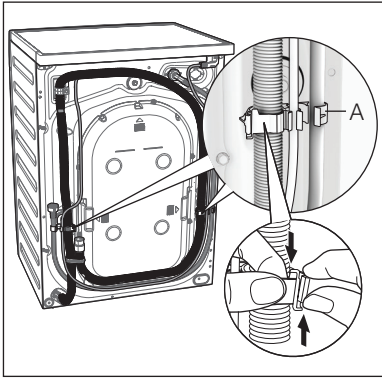

8. Longgarkan ketiga-tiga bolt.
9. Tarik keluar peruang plastik.

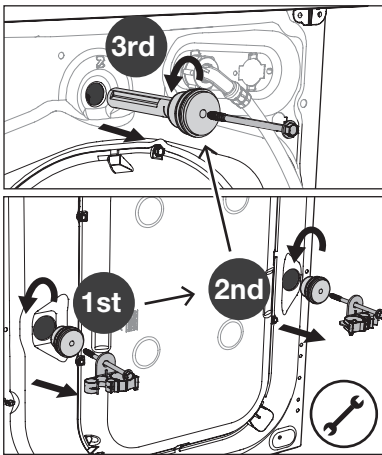

10. Letakkan penutup plastik di dalam lubang. Anda boleh menjumpai penutup ini di dalam beg manual pengguna.

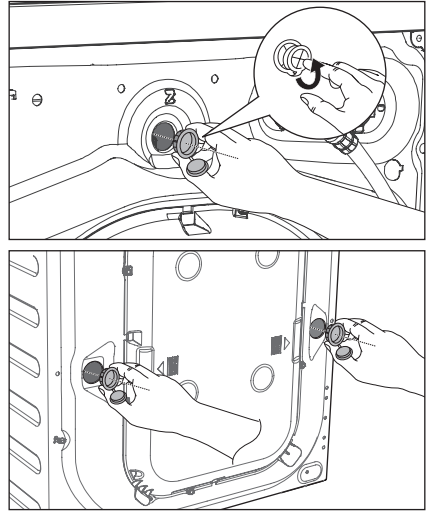
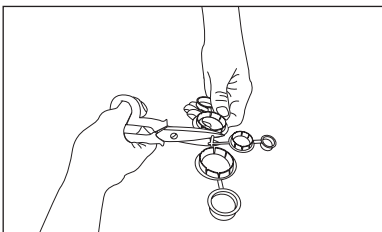

## 11.2 Kedudukan Mesin

Penting untuk mesin basuh anda didudukan kukuh dan rata di atas lantai untuk memastikan operasi yang betul.

Perkakas tidak boleh dipasang di belakang pintu boleh dikunci, pintu gelongsor atau pintu dengan selak pada sisi bertentangan pintu mesin basuh. Gunakan paras spirit pada atas dan sisi mesin basuh untuk memeriksa paras.

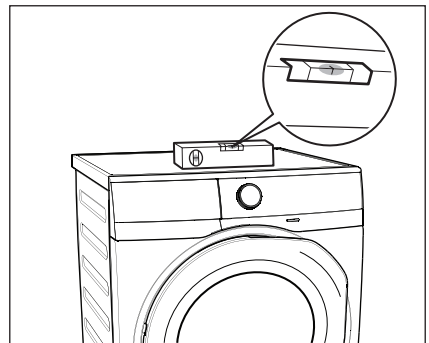

Jika anda tidak mempunyai paras spirit, sebagai panduan gunakan hujung bingkai pintu, almari atau bangku untuk memastikan mesin basuh selaras.

Longgarkan atau ketatkan kaki untuk melaras ketinggian. Pelarasan yang betul paras perkakas mencegah getaran, bunyi bising dan pergerakan perkakas semasa beroperasi.

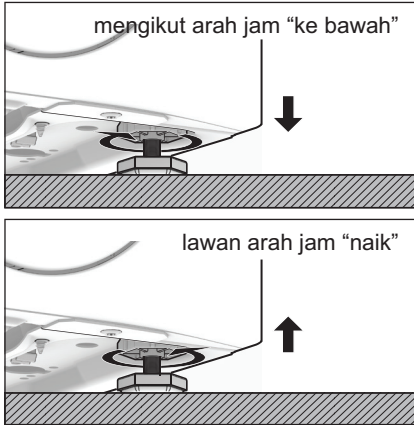

Apabila mesin basuh selaras, cuba goyangkannya dari sudut ke sudut. Jika ia bergoyang, laras semula kaki sehingga ia selaras dan tidak bergoyang.

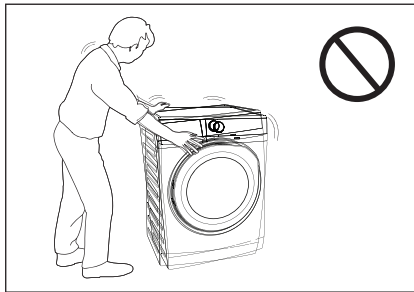

Jangan letakkan kadbod, kayu atau bahan yang sama di bawah mesin untuk meratakan lantai. Pasangkan mesin di atas lantai yang rata dan keras. Pastikan peredaran udara di sekeliling mesin tidak di ganggu oleh permaidani, dan sebagainya.

Periksa mesin supaya tidak menyentuh dinding atau almari.

### 11.3 Saliran Air Masuk

Sambungkan hos penyaliran air masuk kepada pili air dengan alur BSP 3/4".

Gunakan hos yang dibekalkan bersama mesin basuh. **JANGAN GUNAKAN HOS LAMA.**

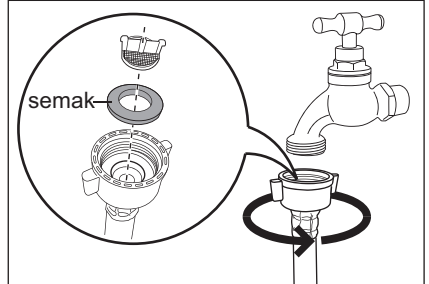

Bahagian hujung lain hos air masuk yang bersambung dengan mesin boleh dipusingkan ke arah mana sekalipun. Longgar ikatan, pusingkan hos dan ketatkan semula ikatan, pastikan tiada kebocoran air.

Hos air masuk tidak boleh dipanjangkan. Jika ia terlalu pendek dan anda tidak mahu mengalihkan pili air, anda perlu membeli hos baru yang lebih panjang dan yang dibuat khusus untuk kegunaan seperti ini.

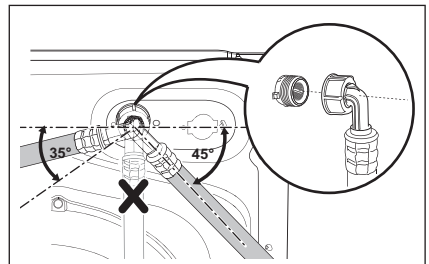

### 11.4 Penyaliran Air

Bahagian hujung hos saliran boleh diletakkan kedudukannya dengan tiga cara:

- Disangkutkan pada pinggir singki, menggunakan alat pandu hos plastik yang dibekalkan bersama dengan mesin.

**Memasang Alat Pandu Hos**

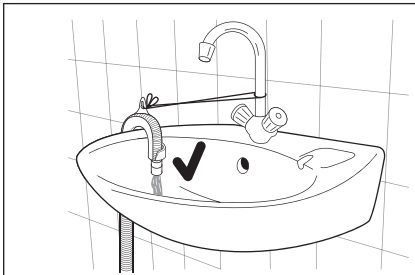
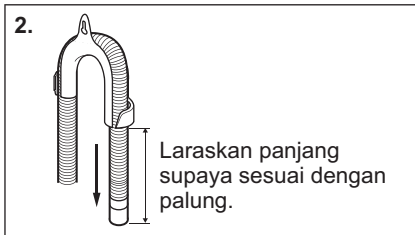
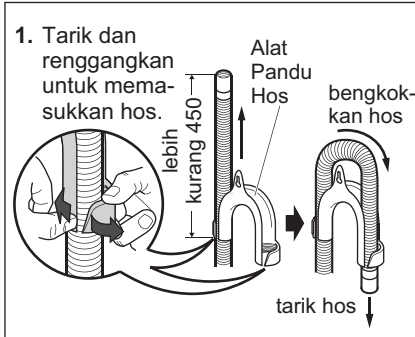

Dalam kes ini, pastikan hujungnya tidak dapat terlepas apabila mesin dikosongkan. Ini dapat dilakukan dengan mengikatnya pada pili dengan tali atau dengan melekapkannya pada dinding.

• **Di dalam singki, cabang paip saliran.**

Cabang ini mestilah terletak di bahagian atas perangkap supaya bengkokkan berada sekurang-kurangnya 60 cm dari lantai.

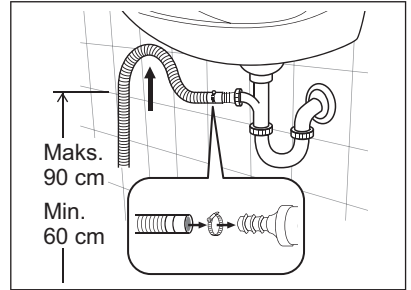

Tekan hos saliran ke dalam spigot dan ketatkan dengan klip, pastikan gelung terbentuk pada hos saliran untuk mencegah sisa singki daripada memasuki perkakas.

• **Terus ke dalam paip penyaliran keluar pada ketinggian tidak kurang daripada 60 cm dan tidak lebih daripada 90 cm.**

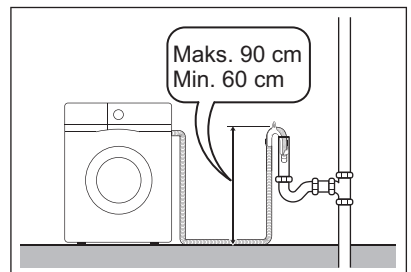

Hujung hos penyaliran air keluar mesti sentiasa berudara, cth. di dalam diameter paip penyaliran air keluar mesti lebih besar daripada diameter di luar hos. Hos air keluar tidak boleh terputar. Terletak di atas lantai; hanya bahagian berdekatan air keluar mesti ditinggikan.

Untuk mesin berfungsi dengan betul, hos air keluar mesti disangkut dengan betul sokongan yang terletak di bahagian atas sebelah belakang perkakas.

## 11.5 Sambungan Elektrik

Mesin ini direka untuk beroperasi pada 220-240 V, fasa tunggal, 50 Hz.



**Sila semak syarat nilai bekalan kuasa diberi yang disebutkan pada Label Rating sebelum anda menyambung kepada bekalan kuasa.**

**“Bekalan kuasa yang tidak betul boleh membatalkan waranti anda.”**

Periksa sama ada bekalan elektrik rumah anda dapat menerima beban maksimum yang diperlukan (2.0 kW), dengan mengambil kira perkakas elektrik lain yang digunakan.



**AWAS!** Sambung mesin pada alur keluar soket terbumi.

Pengilang berhak menolak sebarang tanggungjawab bagi kerosakan atau kecederaan sekiranya gagal mematuhi langkah pencegahan keselamatan di atas.



Jika kabel bekalan kuasa perkakas perlu ditukar, ini perlu dilakukan oleh Pusat Servis kami.

Apabila perkakas dipasangkan, kabel bekalan kuasa mesti boleh diakses dengan mudah.

---



## 12. KEPRIHATINAN ALAM SEKITAR

### 12.1 Bahan Pembungkusan



Bahan yang ditanda dengan simbol ♻ boleh dikitar semula.

>PE<=polyethylene  
>PS<=polystyrene  
>PP<=polypropylene

Ini bermakna bahan tersebut boleh dikitar semula dengan melupuskannya dengan cara yang betul di dalam bekas pemungutan yang sesuai.

### 12.2 Mesin Lama

Gunakan tapak pelupusan yang disahkan bagi perkakas lama. Bersama-sama kita menjaga kebersihan negara!

Simbol  pada produk atau pada bungkusannya menunjukkan bahawa produk ini tidak boleh dianggap sebagai sisa buangan rumah. Sebaliknya, ia hendaklah dihantar ke pusat pungutan yang sesuai untuk mengitar semula perkakasan elektrik dan elektronik.

Dengan memastikan produk ini dilupuskan dengan betul, anda akan membantu menghindarkan berlakunya kemungkinan akibat buruk terhadap alam sekitar dan kesihatan manusia, yang boleh disebabkan jika produk ini dilupuskan tidak dengan sewajarnya.

Untuk maklumat lanjut mengenai kitar semula produk ini, sila hubungi pejabat bandar tempatan, atau khidmat pembuangan bahan buangan rumah anda atau kedai tempat anda membeli produk ini.

### 12.3 Petua Ekologi

Untuk menjimatkan air dan tenaga serta membantu melindungi alam sekitar, kami menasihatkan agar petua berikut dipatuhi:

- Kebiasaannya pakaian kotor boleh dibasuh tanpa pracuci untuk menjimatkan detergen, air dan masa (alam sekitar juga dilindungi!).
- Mesin berfungsi dengan lebih ekonomi jika ia dimuat dengan penuh.
- Dengan prarawatan mencukupi, kotoran dan kesan kotor terhad boleh ditanggalkan; cucian kemudiannya boleh dibasuh pada suhu lebih rendah.
- Sukat detergen mengikut kekasaran air, tahap kotoran dan kuantiti cucian yang mahu dicuci.

## 可能影响制造商保修的重要信息

对健康与安全而言，遵守本手册中的使用说明至关重要。未能严格遵守本手册中的相关要求可能导致人身伤害、财产损失，并且可能影响您根据产品随附的伊莱克斯制造商保修提出索赔。若您因未遵守本手册说明而导致产品故障，则无法就伊莱克斯制造商保修提出索赔。

## 伊莱克斯 – 想你所想！

感谢您购买伊莱克斯电器。您选择的产品凝结了我们数十年的专业经验和创新技术。精巧时尚的外观，尽显人性化设计。因此每次使用它，您都能得到满意的效果。欢迎来到伊莱克斯的世界。

访问我们的网站：



获取使用建议、产品手册、故障解决方案以及维修服务信息：

[www.electrolux.com](http://www.electrolux.com)

## 客户关怀和服务

我们建议使用原厂备件。联系客服人员时，请确保可以提供下面的信息。您可以在产品铭牌上找到这些信息。例如型号、PNC、序列号。

 警示/安全警告信息。

 基本信息和使用提示。

 环保信息。

如有更改，恕不另行通知。

## 目录

<b>1. 安全信息</b>	
1.1 使用条件 .....	76
1.2 儿童安全 .....	76
1.3 基本安全提示 .....	76
1.4 安装 .....	77
1.5 使用 .....	77
<b>2. 产品图解</b>	
2.1 组成部分 .....	78
2.2 附件 .....	79
<b>3. 控制面板</b>	
3.1 控制面板说明 .....	80
3.2 程序表 .....	81
3.3 程序 + 选项 .....	83
3.4 选项 .....	84
3.5 设置 .....	86
3.6 启动/暂停 (▶  ) 和添加衣物 (🔗) 触控键 .....	87
<b>4. 首次使用前</b> .....	87

# 目录

<b>5. 日常使用</b>	
5.1 放入衣物	88
5.2 使用洗涤剂 and 洗涤助剂	88
5.3 选项设置	89
5.4 启动程序 (▶  )	90
5.5 中断程序	90
5.6 更改程序	90
5.7 更改选项	90
5.8 打开机门	90
5.9 程序结束	90
5.10 洗衣程序已完成, 但滚筒内仍然有水	91
5.11 AUTO Off 功能	91
<b>6. 洗衣提示</b>	
6.1 对衣物进行分类	92
6.2 温度	92
6.3 放入衣物之前	92
6.4 最大衣物量	92
6.5 去除污渍	92
6.6 洗衣粉使用类型和用量	93
<b>7. 国际洗衣代码符号</b>	94
<b>8. 保养和清洁</b>	
8.1 外部清洁	95
8.2 除垢	95
8.3 每次洗衣后	95
8.4 利用“Tub Clean”程序进行保养洗涤	95
8.5 清洁投放抽屉盒	95
8.6 清洁抽屉盒的凹槽	96
8.7 清洁进水管过滤器	96
8.8 预防霜冻	97
<b>9. 故障诊断</b>	
9.1 可能的原因	98
9.2 紧急开门	101
<b>10. 技术参数</b>	102
<b>11. 安装</b>	
11.1 拆除包装	102
11.2 洗衣机放置	104
11.3 进水	105
11.4 排水	106
11.5 电气连接	107
<b>12. 关注环保</b>	
12.1 包装材料	107
12.2 废旧洗衣机	107
12.3 环保提示	107

# 1. 安全信息

## 1.1 使用条件

本设备仅限家庭及下述类似条件中使用：

- 商店、办公室和其他工作环境中的员工厨房；
- 农场；
- 供酒店、旅馆和其他住宿环境中的客人使用；
- 宵夜和早餐环境；
- 公寓的公共区域或洗衣店。



**警告！** 本设备不能通过外部开关装置（如定时器）供电，也不能连接到公用开关的电路上。

为了您的安全和确保正确使用洗衣机，在安装和首次使用本机前，请仔细阅读本用户手册，包括相关的提示和警告。

为避免不必要的错误和意外，务必要确保本机的所有使用者都充分熟悉其各项操作特性和安全特性。

请妥善保留本说明书，搬运或出售本机时，应确保随机附带本说明书，以便机器使用寿命内的每位使用者都能适当了解机器的使用方法和安全须知。

## 1.2 儿童安全

- 除非有适当的监督指导，否则本洗衣机不供儿童或体弱多病者使用。
- 应对儿童加以照看，确保他们不会玩耍洗衣机。
- 包装材料组件（如塑料薄膜、聚苯乙烯泡沫）可能危及儿童安全 – 存在窒息危险！请妥善将其放在儿童无法触及的地方。
- 将所有洗涤剂放在儿童无法触及的安全地方。
- 确保儿童或宠物不会爬入滚筒。
- 本机器提供儿童锁保护功能（），以避免儿童误操作控制面板。（参考第 86 页）。

## 1.3 基本安全提示

- 以任何方式更改产品规格或试图改装本产品的做法都是危险的。
- 高温洗衣程序运行期间，机门玻璃可能会很热。切勿触摸！
- 确保宠物不会爬入滚筒内。为避免这种情况的发生，请在使用本机前对滚筒内进行检查。
- 任何诸如硬币、别针、钉子、螺丝钉、石块等物品或任何其他坚硬、锋利材料都可能造成大面积损坏，因此不得放入洗衣机中。
- 袜子、蕾丝带、可洗皮带等小件物品应放在洗衣袋或枕套内洗涤，因为这些小物件可能会落入洗衣桶与内滚筒之间。

- 仅使用建议用量的衣物柔顺剂和洗涤剂。如果用量过大，可能会损伤衣物或洗衣机。请遵循制造商的用量建议。
- 不要使用洗衣机洗涤带坚硬部分的物品、未摺边或开线的衣物。
- 每次使用、清洁以及保养本机之后，始终要拔下电源插头并关闭水龙头。
- 本机不适合身体残障、感官或精神功能减退以及缺乏相关经验和知识的人员（包括儿童）使用，除非有负责其安全的人员对其使用本机给予监督或指导。
- 在任何情况下，不应尝试自行维修洗衣机。由缺乏相关经验的人员维修洗衣机可能会导致人身伤害或设备严重故障。请联系您当地的维修服务服务中心。应始终坚持使用原厂备件。

## 1.4 安装

- 本机非常沉重。搬动时应多加小心。
- 拆除本机的包装时，请检查洗衣机是否有任何损坏。如有任何疑问，请勿使用，并联系维修服务服务中心。
- 使用洗衣机之前，必须拆除所有包装材料和运输螺栓。否则，本产品和其他财物可能会严重受损。请参阅本用户手册的相关章节。
- 洗衣机安装完毕后，检查并确认进水管和排水管没有被洗衣机压住，且工作台面不挤压电源线。
- 如果将本机摆放在铺有地毯的地板上，请适当调整底脚，以便空气能够自由流通。
- 安装完毕后，始终要确保水管及水管连接处没有漏水现象。
- 安装本机所需的水管敷设工作应由合格的水管工人完成。

- 安装本机所需的电气工作应交由合格的电工完成。

 **可能触电！**如果连接洗衣机的插座不是接地插座。请勿触摸湿衣。

 **出于安全的原因，我们强烈建议您不要使用转接插座、拖线板和接驳加长电源线等。**

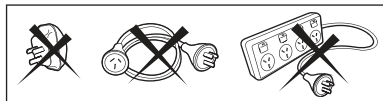

## 1.5 使用

- 仅洗涤适宜机洗的衣物。请遵循每件衣服标签上的洗涤说明。
- 不得在本机内放入过量衣物。请参阅本用户手册的相关章节。
- 开始洗衣前，确保已掏空所有衣袋、扣紧纽扣并拉好拉链。避免洗涤有磨损或破损的物品，并在洗衣前处理颜料、油墨、锈迹及草叶等污渍。带钢圈的胸罩不得机洗。
- 接触过挥发性石油产品的衣物不得机洗。如果使用了挥发性的清洗液，那么一定要注意确保先除去衣物上的清洗液，然后再放入洗衣机中。
- 从电源插座上拔下插头时，切勿拽拉电源线；始终应用手握住插头。
- 如果电源线、控制面板、工作台面或底座发生损坏而露出洗衣机内部，请勿使用洗衣机。

## 2. 产品图解

### 2.1 组成部分

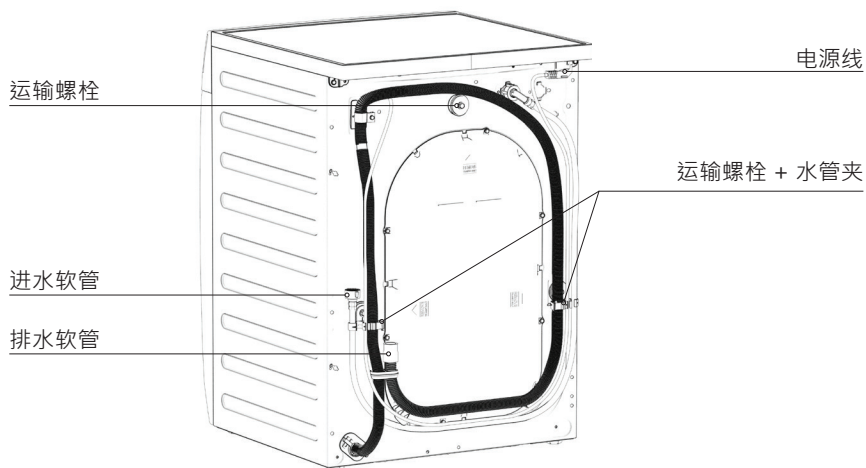
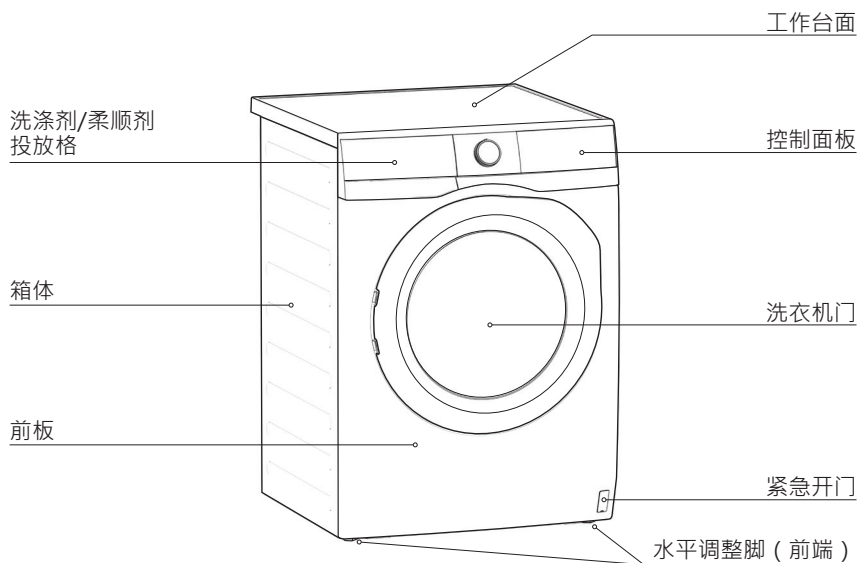

洗涤剂/柔顺剂投放格  
(参考第 88, 95 页)

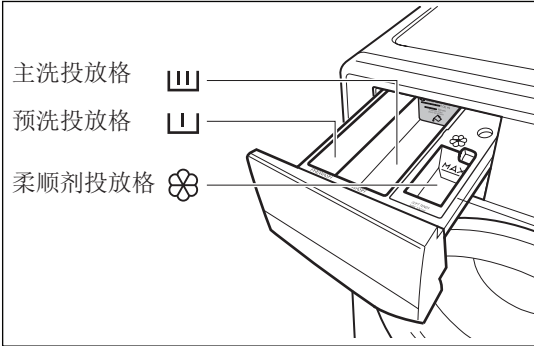

洗衣机门 (当打开)  
(参考第 88 页)

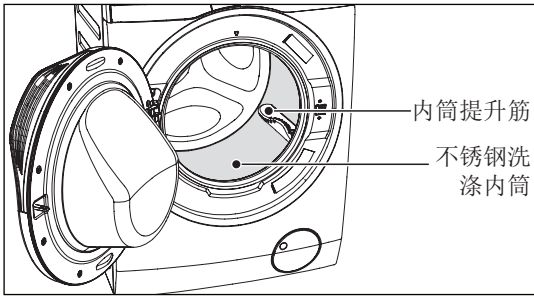

紧急开门

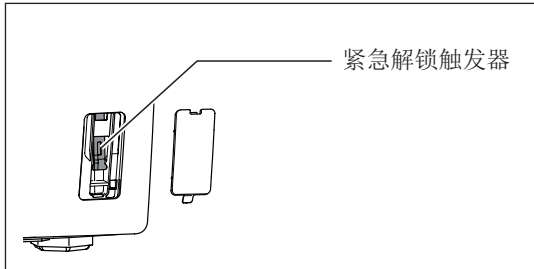

水平调整脚

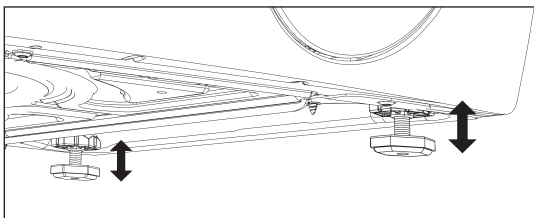

运输螺栓 (什么时候删除)

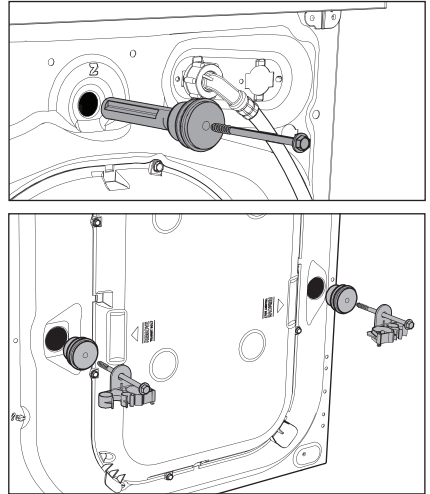

**!** 小心: 在使用洗衣机前, 必须拆除所有运输 (3 组成部分)。

## 2.2 附件

塑料盖

用于在卸下运输螺栓后堵住机箱背部的孔口。



塑料软管导向套

用于将排水管连接在水槽边缘。

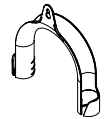

## 3. 控制面板

### 3.1 控制面板说明

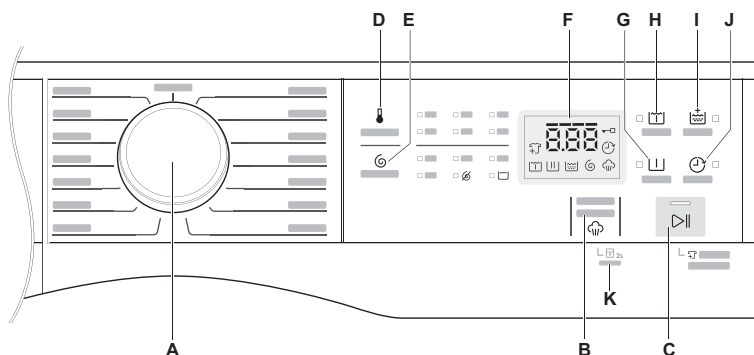

**A** 程序旋钮

**B** 蒸汽触控按钮

**C** 启动/暂停 和添加衣物触控键

**D** 温度触控按钮

**E** 脱水选择触控按钮

**F** 显示屏

**G** 预洗触控按钮

**H** Soak (浸泡)触控按钮

**I** 加强漂洗触控按钮

**J** 预约剩余时间触控按钮

**K** 儿童安全锁功能

#### 显示屏

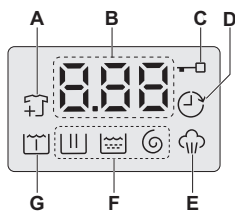

**A** 添加衣物功能图示

**B** 洗衣循环时间/预约时间

**C** 门锁标图标

**D** 预约图标

**E** 蒸汽洗涤阶段图标

**F** 洗衣阶段图标:

▨ 清洗,

▨ 漂洗,

⊙ 旋转

**G** 浸泡



### 3.2 程序表







程序; 温度	脱水 速度	最大衣物量 (晾衣服);	衣物类型和脏污程度
<b>Off</b> (关);	—	—	位置 “Off” 将重置程序/关闭洗衣机。
<b>Cottons</b> (棉质织物); Cold 至 90°C	1200 rpm	<b>Max.<sup>1)</sup></b>	白色和彩色棉质织物。
<b>Mixed</b> (混合织物); Cold 至 60°C	1200 rpm	4 kg	化纤或混合面料织物。
<b>Delicates</b> (纤幼织物); Cold 至 40°C	1200 rpm	4 kg	的精致织物, 如丙烯酸织物、纤维胶、聚酯类衣物。
<b>Bedding</b> (床上用品); Cold 至 40°C	800 rpm	3 kg	单件化纤毛毯、被罩和床单等用品的专用程序。
<b>Energy Saver</b> (节能洗); 40°C 至 60°C <sup>2)</sup>	1200 rpm	<b>Max.<sup>1)</sup></b>	脏污程度一般的白色和不褪色棉质衣物。设定此程序可达到良好洗涤效果并降低能耗。洗衣程序的时间将延长。
<b>Tub Clean</b> (桶清洗); 60°C	—	—	适用于清洗洗衣桶。
<b>Spin</b> (脱水)	1200 rpm	<b>Max.<sup>1)</sup></b>	对衣物脱水并排空滚筒中的水。
<b>Rinse + Spin</b> (漂洗 + 脱水)	1200 rpm	<b>Max.<sup>1)</sup></b>	漂洗衣物并进行脱水。
<b>Baby Care</b> (婴儿); Cold 至 40°C	1200 rpm	4 kg	脏污程度一般的棉质婴儿衣物和精致针织衣物。

程序; 温度	脱水 速度	最大衣物量 (晾衣服);	衣物类型和脏污程度
<b>Quick 15</b> (分钟快洗); Cold 至 30°C	1200 rpm	1.5 kg	轻微肮脏合成纤维或混合型面料。
<b>Daily 39</b> (日常 39); 30°C 至 40°C	1200 rpm	EWF7524D3WB EWF8024D3WB <u>4 kg</u> EWF9024D3WB 5 kg	彩色棉, 如男女衬衫、毛巾和内衣, 一般脏污程度。
<b>Full Wash 60</b> (全洗 60); 30°C 至 60°C	1200 rpm	<b>Max. <sup>1)</sup></b>	每天穿彩色棉布衣服, 例如衬衫, 衬衫, 毛巾和内衣。正常水平土壤的理想选择。

1) 最大容量取决于洗衣机的型号 (请参阅控制面板上的定义)。

2) 满负荷洗涤脏污程度一般的棉质衣物时, 建议使用贴有节能节水能效标签的节能洗程序, 并选择 60°C 的温度选项。

### 3.3 程序 + 选项

程序	选项						
	 No Spin	 Rinse Hold	 Soak	 Extra Rinse	 Prewash	 Delay End	 Hygienic Care <sup>1)</sup>
Cottons	■	■	■	■	■	■	■
Mixed	■	■	■	■	■	■	■
Delicates	■	■	■	■	■	■	■
Bedding	■	■	■	■	■	■	■
Energy Saver	■	■	■	■	■	■	■
Tub Clean							
Spin	■						■
Rinse + Spin	■	■					■
Baby Care	■	■		■	■	■	■
Quick 15	■	■					■
Daily 39	■						■
Full Wash 60	■	■		■			■

1) 蒸汽选项仅可在 40 - 90 °C 温度时组合使用。

### 3.4 选项

#### 温度触控按钮

如果希望使用不同于洗衣机建议的温度洗涤衣物，请多次按该按钮升高或降低洗衣温度。

#### 脱水选择触控按钮

如果希望使用不同于洗衣机建议的转速为衣物脱水，请反复按此触控按钮加快或减慢脱水转速。



#### • 不脱水 No Spin ( )

“不脱水”选项将取消所有脱水阶段并增加漂洗次数。

#### • 延迟脱水 Rinse Hold ( )

选择此选项时，将不排空最后一次漂洗时的水，并且滚筒会定时旋转以防止衣物褶皱。

机门仍将保持锁定，以提醒您必须排空滚筒内的水。

 机门将保持锁定并且滚筒内有水。要继续洗衣程序，必须按  (启动/暂停)。

#### Soak (浸泡)

该选项可让您在进入主要洗涤阶段之前以及开始洗涤时，深入浸泡弄脏的衣服和有污渍的衣物。

该选项将延续选择程序的工作时间长度大约 50 分钟，并比原先更多地用水来洗涤工作的步骤如下。

 在“浸泡”隔间中添加用于“Prewash  ”的清洁剂。

#### 1. 加水 和 旋转滚筒

(使用时间大约 20 分钟)

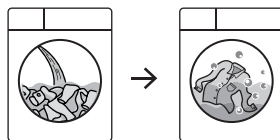

在按下按钮 Start/Pause 后，机器将开始加水进入滚筒并慢慢旋转滚筒，来分散衣物和溶解洗衣粉。

#### 2. 浸泡衣物 (使用时间大约 30 分钟)

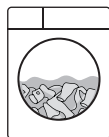

机器将进入浸泡衣物的程序，滚筒将静止并偶尔转动来分散衣物。

3. 在浸泡衣物完成之后，机器将进行再次检查水系统，并进入下一个选择的程序，用的是原先浸泡衣物的水。

#### 注意：

如果您不需要使用原先浸泡衣物的水来洗涤衣物，请按如下程序操作。

1. 按下按钮 Start/Pause 来停止洗衣机的运行，然后将程序旋钮旋转到“Off”以关闭机器。
2. 之后选择需要的洗衣程序，再次按下按钮 Start/Pause 来开始选择的重新洗涤的程序，机器将自动检查和排放出滚筒里的水并再次加入新的水来用于洗涤。

#### 注意：

- 可选择任何温度，但建议该周期使用“冷 (Cold)”水，因为较热的水可能会造成色斑。
- 在正常的洗涤周期中，建议使用一定量的洗涤剂。必要时，可以使用适用于纤维的漂白剂或浸泡剂，将它们倒入洗涤剂浸泡槽中即可。

## 加强漂洗触控按钮 (Extra Rinse)

此选项建议用于对洗涤剂过敏的人群以及水质很软的地区。选择该选项，为该程序添加 2 次漂洗。此选项的标志将亮起。

## 预洗触控按钮 (Prewash)

如果希望在开始主洗之前预洗衣物，请选择此选项。此选项适合洗涤脏污程度严重的衣物。此选项的标志将亮起。

当设定此功能时，请将洗涤剂放入“”投放格中。此功能将延长程序的持续时间。

## 预约 触控按钮 (Delay End)

开始该程序之前，该选项可让您将洗涤程序的结束时间从至少 1 小时界定为至多 20 小时。

**i** 如果程序持续时间大于 3 小时（最小值），则“延迟结束”选项的起始值为 4 小时。

按下“延迟结束”触摸板，选择您想要的结束时间。显示器显示时数，触摸板上面的指示灯处于亮起状态。

**i** 选择洗涤程序之后，必须选择该选项，然后再按下“开始/暂停”触摸板。

例如，如果您所选程序的持续时间为 3.20 小时，可将“延迟结束”时间定义为 6 小时。这意味着您的洗涤程序将在 6 小时内结束。（请参见下图）

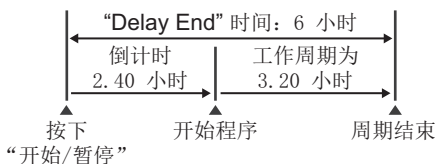

选择“延迟结束”时间后，按下“开始/暂停”触摸板，开始该程序。然后洗衣机将进入倒计时并在显示器上每隔数小时就更新时间一次，直到它到达洗涤周期的起点。如果开始该程序之后您想修改或取消“延迟结束”选项，请执行以下步骤：

- 按下“开始/暂停”触摸板，将洗衣机设置为“暂停”；
- 反复按下“延迟结束”触摸屏，直至显示屏限时延迟时间“h”，从而取消选择该选项；
- 按下“开始/暂停”，开始该程序。

## 蒸汽洗涤触控按钮 (Hygienic Care)

选择此选项可在漂洗周期后增加约 30 分钟的蒸汽翻滚时间。

### 注意：

- 在蒸汽洗涤程序期间，蒸汽不一定在滚筒内清晰可见。蒸汽将在滚筒下方生成，然后自然上升并渗入衣物中。
- 整个蒸汽洗涤期间可能都不会出现蒸汽。
- 一半衣物量时，蒸汽洗涤功能效果更佳。
- 蒸汽程序结束时，衣物将变得更温暖、更柔软并从滚筒中脱离。

**i** 如果选择了蒸汽洗涤选项，漂洗温度将会升高。

在蒸汽洗涤期间，洗衣机的排水管可能会排出蒸汽，这属于正常现象，不会引起报警。

### 3.5 设置

#### 儿童安全锁功能 (🔒)

本机提供儿童安全锁功能，可以在洗衣机无人看管时保持机门关闭，从而不必担心洗衣机对儿童造成伤害或本身发生损坏。

**i** 按下“启动/暂停”后触摸板的设置此选项。

设定儿童安全锁选项：

- 若要激活此功能，请按住“Hygienic Care (🧼)”触摸屏约 2 秒，图标“🔒”将在显示屏上显示并伴有蜂鸣器声音。

**i** 如果您在启用安全锁时按任何触摸屏，图标“🔒”将在显示屏上闪烁 3 次并伴有蜂鸣器声音。

**i** 在触摸板被锁定。

- 若要禁用此功能，请按住“Hygienic Care (🧼)”触摸屏约 2 秒，图标“🔒”将在显示屏上显示并伴有蜂鸣器声音。

**i** 即使已切断洗衣机电源，此功能仍会保持启用状态。

#### 启用/禁用“洗涤结束蜂鸣模式”

此模式允许您启用或禁用洗涤结束时的蜂鸣声。例如您需要在睡觉时进行洗涤，希望禁用该蜂鸣声，从而在大约 1 小时的洗涤结束后，洗衣机不会发出声音打扰您的休息。

**i** 不会禁用错误警告蜂鸣声，例如严重故障。

- 若要禁用蜂鸣器声音，请同时按下“Temp 和 Spin”触摸屏约 3 秒，图标“🔕”将在显示屏上显示并伴有蜂鸣器声音。
- 若要恢复默认配置，请同时按下这两个触摸屏约 3 秒，图标“🔕”将在显示屏上显示并伴有蜂鸣器声音。

### 3.6 启动/暂停 (▷||) 和添加衣物 (👔) 触控键

此触控键有两个功能：

#### 1. 启动/暂停 (▷||)

选定所需程序和选项后，按下此触控键启动洗衣机。启动/暂停指示灯将停止闪烁并常亮，直到水位超过机门的下缘，这时，指示灯会熄灭。如果您已选择“Delay End”选项，倒计时将开始并显示在显示屏上。

如需中断正在运行的程序，按下此触控键即可暂停洗衣机，启动/暂停指示灯闪烁。

如需从程序被中断的时候重新启动程序，再次按下此触控键，启动/暂停指示灯将停止闪烁。

#### 2. 添加衣物 (👔)

 只有在显示屏上显示的图标“👔”时才能添加衣服。

1. 按下“Start/Pause”触控键暂停程序。
2. 打开洗衣机门之前，请等待机器完全停止（等待门锁“🔒”图标关闭）。
3. 添放衣物，并关上机门。
4. 再次按下“启动/暂停”触控键恢复程序。

## 4. 首次使用前

 在安装过程中还是第一次使用前，你可以在机器观察到了一些水。这是留在机器在出厂全功能测试后，保证了机器的剩余的水提供给客户完美的工作秩序，是无需担心。

1. 确保电气和水路连接符合安装说明。
2. 向洗涤剂投放格内加入 2 升水用于主洗阶段。此操作将启动排水系统。

3. 洗衣机内不添加衣物，选择棉质织物程序并将温度设定为 90 °C，以去除制造过程中内筒和外筒上的残留物，然后启动洗衣机。

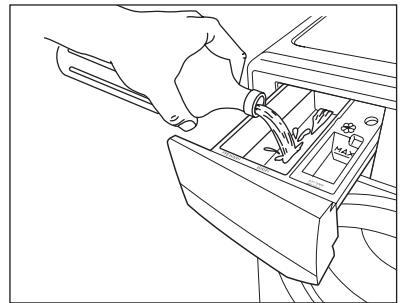

## 5. 日常使用

### 5.1 放入衣物

1. 打开水龙头。
2. 将电源插头插入电源插座。
3. 将程序选择旋钮旋转至需要的程序。

洗衣机将针对选定的程序建议洗衣温度，并自动选择脱水速度值。

选择旋钮可以顺时针或逆时针旋转。

4. 小心地向外拉动机门拉手，打开机门。

检查并取出可能落入折边处的物件（如果有的话）。

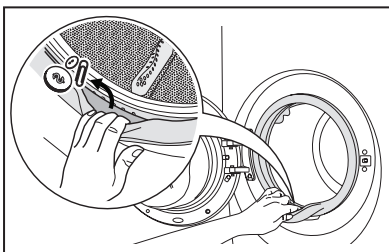

5. 将衣物放入滚筒内，每次放入一件，并尽量将衣物抖开。（参考第 92 页）
6. 关闭机门。

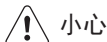

小心

确保门封和机门之间没有夹住任何衣物。

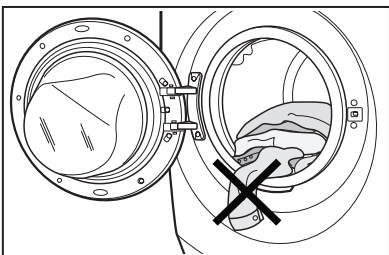

### 5.2 使用洗涤剂和洗涤助剂

 在使用洗衣粉之前请阅读 93 页洗衣粉使用类型和用量。

1. 洗涤剂投放抽屉盒

洗涤剂投放抽屉盒分为三个投放格。

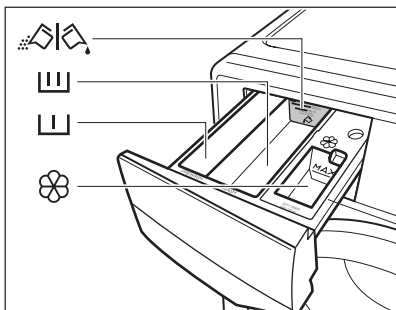

-  主洗投放格

此投放格用于投放所有洗衣程序使用的洗涤剂。

-  预洗投放格

此投放格仅用于在选择预洗程序时投放洗涤剂。

-  洗涤剂挡板

用于投放粉状或液体洗涤剂的挡板。

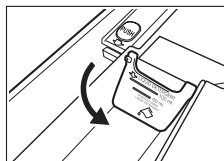

位置向下：  
适合投放液体洗涤剂

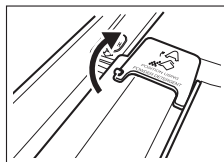



位置向上：  
适合投放粉状洗涤剂

-  柔顺剂投放格

此投放格用于投放衣物柔顺剂和上浆剂。



### **i** 使用液体洗涤剂时：

- 请勿使用胶状或粘稠的液体洗涤剂。
  - 投放的液体洗涤剂不得超过最大液位线。
  - 请勿设定预洗阶段。
  - 请勿设定预约功能。
2. 量取适量的洗涤剂和衣物柔顺剂：
- 拉出洗涤剂投放抽屉盒，直到拉不动为止。
  - 视需要量取适量洗涤剂，倒入主洗投放格中 。
  - 如果要运行“预洗”阶段，请将洗涤剂倒入标有  的投放格中。

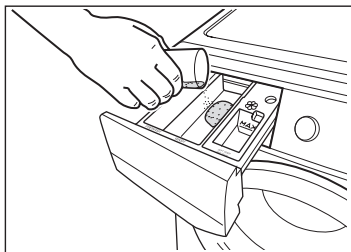

- 如果需要，可将衣物柔顺剂倒入标有  的投放格中。

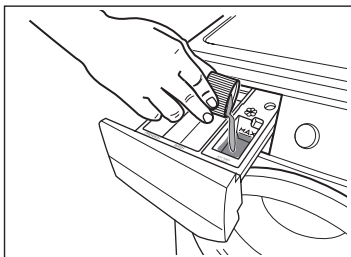

### **i** 用量不得超过抽屉盒的最大标记“MAX”

建议使用浓缩织物柔软剂时先用水稀释柔软剂。

- 轻轻关上抽屉盒。

### **i** 在洗涤程序完成后，洗涤剂、织物柔软剂和水可能会沉积在洗涤剂料盒里。建议经常清洗洗涤剂料盒，以清除沉积物。

## 5.3 选项设置

1. 如果希望使用不同于洗衣机建议的脱水速度和温度洗涤衣物，请反复按脱水“Spin”和温度“Temp”触控按钮更改脱水速度和温度。

如果希望使用特殊功能洗涤衣物，根据需要按相应的选项触控按钮。

### **i** 注释

- 根据选定的洗衣程序的不同，可以组合使用各种不同的功能。
  - 如果选择与预设洗涤程序不兼容的选项，“---”消息将闪烁，并发出哔哔声。
2. 如果希望预约洗衣程序，按预约触控按钮“Delay End”选择洗衣机的预约时间。

## 5.4 启动程序 (▷||)

要启动程序，请按启动/暂停 (▷||) 触控按钮，对应的指示灯将停止闪烁，显示屏上将显示默认的程序持续时间。

程序启动约 15 分钟后：

- 洗衣机将根据衣物类型和衣物量自动调整选定的程序持续时间。
- 显示屏将显示调整后的程序持续时间。

### 注意！

如果在程序正在运行时按下任何触控键，显示屏将显示“---”消息，并发出哔哔声。

## 5.5 中断程序

- 要暂停程序，请按启动/暂停按钮。对应的标志将开始闪烁。
- 再次按启动/暂停触控按钮。程序将继续运行。

## 5.6 更改程序

要更改正在运行的程序，只能关闭洗衣机电源。

- 将程序选择旋钮旋转至“Off”位置，取消程序并关闭洗衣机。
- 将程序选择旋钮旋转至新的程序位置，设定新的选项，然后再次按“启动/暂停”触控按钮。

 在此期间，洗衣机不会排水（除了程序；Spin, Rinse + Spin, Tub Clean）。

## 5.7 更改选项

程序启动后，只能更改部分选项。

1. 按启动/暂停触控按钮。对应的标志将开始闪烁。
2. 更改选项。
3. 再次按启动/暂停触控按钮。程序将继续运行。



## 5.8 打开机门

洗衣程序或预约功能运行时，机门将保持紧锁状态，同时显示屏显示“”标志。首先按启动/暂停触控按钮，将洗衣机设为“PAUSE”（暂停）状态。待门锁标志熄灭后，即可将机门打开。

如果门锁标志“”没有消失，表示洗衣机已经在加热，并且水位高出机门底边，或者滚筒正在转动。这种情况下，机门将无法打开。如果您需要打开它，你必须沥干水开门。（阅读段落“要进行排水”）

 如果是紧急情况下需要立即打开机门。请阅读“紧急开门”第 101 页上。

## 5.9 程序结束

- 洗衣机将自动停止运行。
- 提示声将响起。
- 显示屏将显示“”。
- 启动/暂停触控按钮的标志将熄灭。
- 门锁标志“”将熄灭。
- 将衣物从洗衣机内取出。确保滚筒已完全清空。
- 保持机门微开，以免滋生霉菌和产生异味。
- 关闭水龙头。

### 注释

在洗涤程序结束时，洗涤剩余时间可突然从 7 分钟或更短时间缩短至 0 分钟，这是因为在自动感应衣服容量时所预估的总洗涤时间过长。在某些情况下（负荷完美平衡），在自动感应衣服容量之后，洗涤时间可能会短于预估时间。这是机器的正常工作，因此不必担心，因其并不会影响洗涤效果。



## 5.10 洗衣程序已完成，但滚筒内仍然有水

(使用选项“Rinse Hold (  )”)

- 滚筒将定时转动，以防止衣物起皱。
- 该指标“Start/Pause”闪烁，提醒您沥干水。
- 门锁标志“  ”将亮起。机门保持紧锁状态。

您必须将水排空才能打开机门。

**要进行排水：**

1. 按下“Start/Pause  ”触摸板。  
洗衣机排水并按照所选程序的最大脱水速度旋转。  
或者，按“Start/Pause”触摸板之前，您可以按下“Spin”触摸板改变旋转速度。如果您只想排水，则可以选择“No Spin (  )”，然后按下“Start/Pause”触摸板。洗衣机将排水和旋转。
2. 程序结束时，门锁标志“  ”将熄灭，这时可以打开机门。
3. 将程序选择旋钮旋转至“Off”位置，停用洗衣机。

 **注意：**

大约 18 小时后，如果您不按下“开始/暂停”触摸板，洗衣机将自动排水和旋转。

## 5.11 AUTO Off 功能

洗衣程序结束 5 分钟后，如果未关闭洗衣机，节能功能将会开启。

当洗衣机处于待机模式时，节能功能可以降低能耗。

- 所有标志将熄灭，同时显示屏将关闭。
- 启动/暂停触控按钮的标志将缓缓闪烁。
- 按动其中一个触控按钮可停止节能状态。

## 6. 洗衣提示

### 6.1 对衣物进行分类

请遵循每件服装标签上的洗衣代码符号以及制造商的洗涤说明。对衣物进行以下分类：白色织物、彩色织物、化纤织物、纤幼织物、羊毛织物。

### 6.2 温度

90°C	脏污程度一般的白色棉麻类织物（如茶巾、毛巾、桌布、床单等）。
60°C 50°C	脏污程度一般且不褪色的棉麻或化纤类衣物（如衬衫、睡袍、睡衣等）或者脏污程度较轻的白色棉质衣物（如内衣裤）。
40°C 30°C Cold	精致织物（如网眼窗帘），混合面料衣物（包括化纤衣物）以及带“纯新羊毛、可机洗、不缩水”标签的羊毛衣物。

### 6.3 放入衣物之前

- 确保衣物内没有留下任何金属物件（如发夹、别针、饰针）。



- 扣好枕套、拉紧拉链，扣合钩扣和按扣。系好所有腰带或长带子。

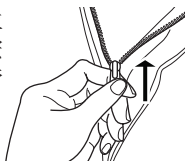

- 在洗衣袋中洗涤胸罩、连裤袜和其他精细织物，您可以在超市购买洗衣袋。
- 请确保棉纤收集器与棉质衣物分开洗涤。
- 切勿将白色与彩色衣物一同洗涤。白色衣物可能会在洗衣过程丧失洁白度。

- 新的彩色衣物在初次洗涤时可能会掉色，因此第一次应单独分开洗涤。
- 开始洗衣之前，先祛除顽固污渍。
- 可用专用洗涤剂或膏状洗涤剂擦拭特别脏污的部位。应小心谨慎地处理窗帘。可取下钩子或者将它们系好后放入洗衣袋或洗衣网内。

### 6.4 最大衣物量

程序表部分给出了建议的最大洗衣量。（参考第 81 页）基本原则如下：

棉麻织物：	装满滚筒，但不能塞得太满；
化纤织物：	不超过滚筒容量的一半；
精致织物和羊毛织物：	不超过滚筒容量的三分之一。

按最大衣物量洗涤可以使水和能源得到高效利用。对于脏污程度严重的衣物，可适当减少衣物量。

### 6.5 去除污渍

只靠水和洗涤剂可能无法去除顽固污渍。因此在开始洗衣前，建议预先对顽固污渍进行处理。

**血渍：**使用冷水处理新沾染的血渍。对于干掉的血渍，先将衣物放入溶有专用洗涤剂的水中浸泡一晚，然后再用肥皂和水搓洗。

**油性颜料：**先用轻油去污剂浸湿，再将衣物平放在软布上，然后轻轻擦拭污渍；进行多次处理。

**干燥的油污：**先用松节油浸湿，再将衣物平放在柔软表面，然后用指尖和棉布轻轻擦拭污渍。

**锈迹：**在热水中溶解草酸，或者在冷水中使用除锈产品。处理早先出现的锈迹时应多加小心，因为此时衣物的纤维素结构已被破坏，所以比较容易破洞。

**霉斑：**用漂白剂处理，然后充分漂洗（仅限白色和不褪色衣物）。

**草渍：**用肥皂轻轻擦洗，然后用漂白剂处理（仅限白色和不褪色衣物）。

**圆珠笔迹和胶水：**先用丙酮溶液(\*)浸湿，再将衣物平放在软布上，然后轻轻擦拭污渍。

**唇膏：**按上述方法用丙酮溶液(\*)浸湿，然后用甲基化酒精进行处理。用漂白剂去除白色织物上残留的任何痕迹。

**红酒：**在溶有洗涤剂的水中浸泡，漂洗后用醋酸或柠檬酸进行处理，然后漂洗干净。用漂白剂处理所有残留痕迹。

**墨水：**根据墨水类型的不同，先用丙酮溶液(\*)浸泡衣物，然后再用醋酸浸泡；用漂白剂处理白色衣物上残留的任何痕迹，然后彻底漂洗干净。

**焦油污渍：**先用去污剂、甲基化酒精或轻质汽油进行处理，然后用膏状洗涤剂擦洗。

(\*) 不要对人造丝织物使用丙酮。

## 6.6 洗衣粉使用类型和用量

该洗衣机需使用低泡洗涤剂，以预防过度磨损、令人不满的洗涤效果以及对机器造成伤害。

专为滚筒洗衣机量身设计的低泡洗涤剂标有“前置式”、“高效”和“HE”，例如滚筒洗衣机冷能模式或“Matic”。

请勿在滚筒洗衣机中使用错误类型的洗涤剂，例如涡轮洗衣机洗涤剂、手洗洗涤剂或皂坯洗涤剂产品。这可能导致泡沫过多、循环时间更长、旋转速度较慢，以及冲洗效果较差和电机过载。

### 洗衣粉用量

正确的洗衣粉的用量不仅可以保证洗涤性能，还可以避免浪费和保护环境。虽然洗衣粉最后能被生物降解，但洗衣粉中含有大量导致生态不平衡的物质。

### 选择洗衣粉用量的根据

- 织物类型，比如精细，羊毛，纯棉等等。
- 衣服的颜色
- 衣服的脏污程度
- 衣服量的多少
- 洗涤温度
- 水的硬度

水的硬度分为不同的硬度等级。

水的硬度可以从供水公司或本地的相关水务管理部门获得。

建议初次使用时根据洗衣粉制造商的说明，然后根据洗涤结果来调整下一次的洗衣粉用量。

洗衣粉用少了会导致：

- 衣服还有残留污垢

洗衣粉用少了会导致：

































- 泡沫过多
- 漂洗结果不好
- 洗涤效果不佳

在下面的情况下需要减少洗衣粉用量：

- 洗涤少量衣服
- 衣服不太脏
- 洗涤过程中泡沫过多

## 7. 国际洗衣代码符号

**i** 织物标签上会带有以下符号，以帮助您选择最佳的衣物护理方式。

 强力洗	 最高洗涤 温度 95 °C	 最高洗涤 温度 60 °C	 最高洗涤 温度 40 °C	 最高洗涤 温度 30 °C	 手洗	 不可洗
 轻柔洗			 			
 漂白	 冷水漂白			 不可漂白		
 熨烫	 高温熨烫最高 200 °C	 中温熨烫最高 150 °C	 低温熨烫最高 110 °C	 不可熨烫		
 干洗	 可用所有溶剂 进行干洗	 可用四氯乙烯、 汽油、纯酒精、 R 111 和 R 113 进行干洗	 可用汽油、纯酒 精和 R 113 进行 干洗	 不可干洗		
 干衣	 平摊干燥	 悬挂干燥	 置于衣架上	 高温  低温 滚筒干燥	 不可滚筒干燥	

## 8. 保养和清洁



**警告！**  
在进行任何清理或维护工作之前，必须断开洗衣机与电源的连接。

### 8.1 外部清洁

仅使用肥皂和温水清洁洗衣机。请擦干所有表面。



**小心！** 不要使用酒精、溶剂或化学制品。

### 8.2 除垢

日常使用的水中通常含有石灰。因此最好定期在洗衣机内使用水软化粉剂。

此项工作应与洗衣分开进行，并应遵照水软化粉剂制造商的使用说明。

这将有助于防止形成石灰质沉积物。

### 8.3 每次洗衣后

将机门敞开一会。这样做有助于防止洗衣机内部发霉和产生异味。在洗衣后将机门敞开还有利于保持门封的密封性。

### 8.4 利用“Tub Clean”程序进行保养洗涤

使用低温洗涤可能会导致残余物在洗衣桶内聚集。

我们建议定期使用“Tub Clean (桶清洗)”程序清洁洗衣桶，清除任何残余物。

若要执行保养洗涤：

- 洗衣桶内应该不含任何衣物。
- 选择“Tub Clean”程序。
- 按下启动/暂停，启动程序。

### 8.5 清洁投放抽屉盒

洗衣粉和洗涤剂投放抽屉盒应定期清洁。

向下按压卡钩并向外拉出，取下抽屉盒。

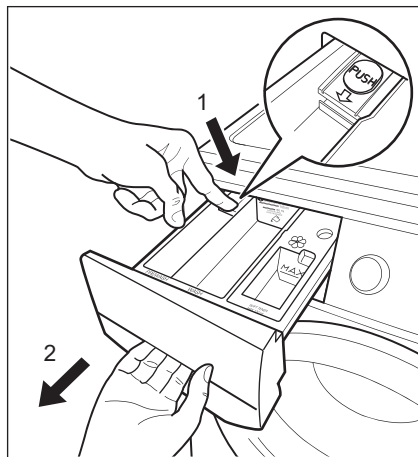

为了便于清洁，应拆下洗涤剂投放格的上部。

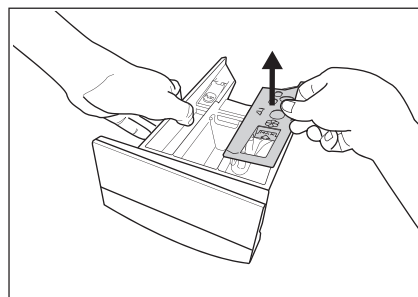

在水龙头下冲洗抽屉盒内部，清除积聚的任何洗衣粉。

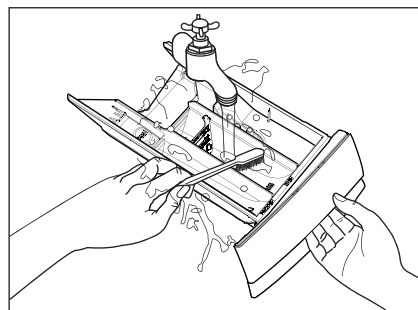

## 8.6 清洁抽屉盒的凹槽

取下抽屉盒后，使用小刷子清洁凹槽，确保去除凹槽上部和下部残留的所有洗衣粉。将抽屉盒放回原位，然后滚筒内不放衣物，空机运行一次漂洗程序。

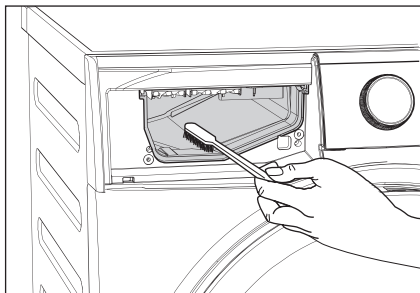

## 8.7 清洁进水管过滤器

如果您当地的水质很硬，或者水中含有石灰质沉积物，进水管过滤器可能会发生堵塞。因此最好时常清洁进水管过滤器。

**要清洁进水管过滤器：**

1. 关闭水龙头。
2. 从水龙头上卸下进水软管。
3. 使用硬毛刷清洁进水软管过滤器。

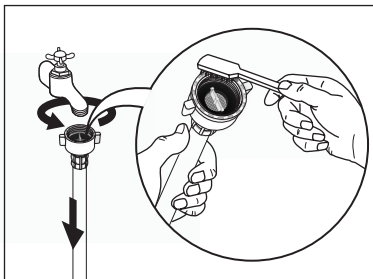

4. 卸下机背的进水软管。

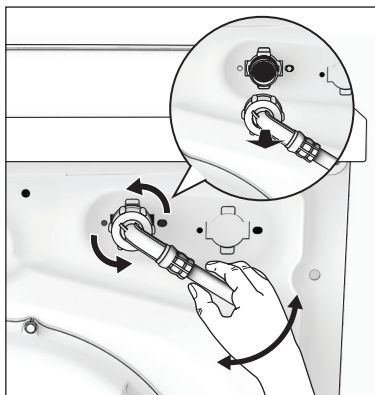

5. 使用硬毛刷或毛巾清洁阀门中的过滤器。

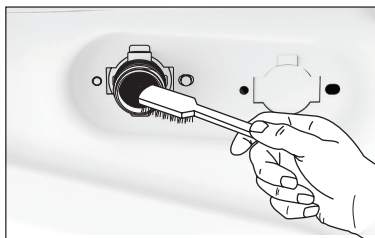

6. 重新装好进水软管。确保连接牢固以防止漏水。
7. 打开水龙头。



## 8.8 预防霜冻

如果洗衣机安装在温度可能降至  $0^{\circ}\text{C}$  以下的地方，请将进水软管和排水泵中残留的水排空。

### 紧急排水

1. 从电源插座上拔下电源插头。关闭水龙头。
2. 取下进水软管。
3. 将排水软管从后部的管托上取下，然后从水槽或水龙头上摘下。

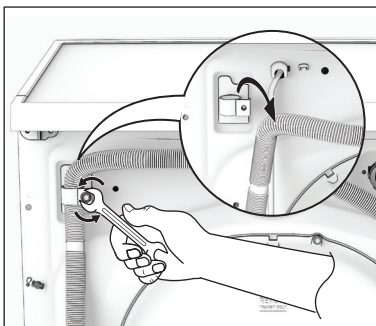

4. 将排水软管和进水软管的末端放在一个容器内。让软管内的水流出。

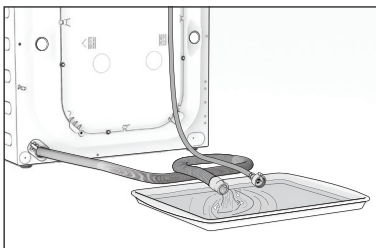

5. 待不再有水流出时，重新装好进水软管和排水软管。



再次使用洗衣机前，确保周围温度高于  $0^{\circ}\text{C}$ 。

## 9. 故障诊断

### 9.1 可能的原因

某些问题是由于缺乏简单维护或疏忽造成的，这类问题无需求助专业人员，可以自己轻松解决。在联系当地维修服务中心之前，请先按照下表所列步骤进行检查。

故障排除后，请按启动/暂停按钮重新启动程序。如果进行全面检查后故障依然存在，请与当地维修服务中心联系。

 **审慎！** 停用该设备你做检查之前。

报警代码：

<b>E10</b>	洗衣机不进水。
<b>E20</b>	洗衣机不排水。
<b>E40</b>	机门未关闭或机门未完全关严。请检查门！
<b>E40</b>	主电源不稳定。等到电源稳定，电器就会自动开启。
<b>E91</b>	装置电子元件间无任何通信。关闭并再次开启。

故障	可能的原因	解决方法
洗衣机不启动：	机门未关闭。（故障代码：E40）	关紧机门。
	插头未正确插入电源插座。	将插头正确插入电源插座。
	电源插座没电。	请检查您的家庭用电设施。
	没有按启动/暂停按钮。	按启动/暂停按钮。
	选择了预约（Delay End）程序。	如果要立即洗涤衣物，取消预约程序。
洗衣机不进水：	主电源不稳定。（如果显示屏上出现 E40。）	等待直至主电源稳定。装置将自动启动。
	水龙头未打开。（故障代码：E10）	打开水龙头。
	排水软管被挤压或扭结。（故障代码：E10）	检查排水软管的连接。
	进水软管中的过滤器发生堵塞。（故障代码：E10）	清洁进水软管过滤器。
洗衣机进水，但随即又将水排出：	机门未完全关严。（故障代码：E40）	关紧机门。
	排水软管的末端太低。（故障代码：E10）	参阅“排水”一节的相关段落。
洗衣机不排水或不脱水：	排水软管被挤压或扭结。（故障代码：E20）	检查排水软管的连接。
	排水泵发生堵塞。（故障代码：E20）	清洗排水过滤器。
	选择了“Rinse Hold”选项。	按启动/暂停键，沥干水。要么选择脱水程序。
	滚筒内衣物摆放不均匀。	暂停运行洗衣机，重新手动将衣物摆放均匀。

故障	可能的原因	解决方法
地面上有水：	使用了过量洗涤剂或不适合的洗涤剂（产生过量泡沫）。	减少洗涤剂用量或使用其他洗涤剂。（参考第 93 页。）
	检查进水软管连接处是否漏水。这种情况有时可能不易察觉，因为水会沿着进水软管流下；因此请检查进水软管是否潮湿。	检查进水软管的连接。
	排水软管破损。	电话服务。
洗衣效果不满意：	使用了过少的洗涤剂或不适合的洗涤剂。	增加洗涤剂用量或使用其他洗涤剂。（参考第 93 页。）
	洗衣前没有预先处理顽固的污渍。	使用去污产品处理顽固污渍。
	没有选择正确的洗涤温度。	检查是否选择了正确的洗涤温度。
	洗涤的衣物量过多。	减少衣物量。
机门无法打开：	程序仍在运行。	等待洗衣程序结束。
	尚未解除机门锁定。	按下电源“开/关”按钮，启动本机。
	滚筒内有水。	要打开机门，必须排干水（请参见 90 页上的“打开机门”）。
	这个问题可能是由电器故障引起。	与服务中心联系。如果你需要打开门，（参考第 101 页）“紧急开门”。
洗衣机振动或有噪音：	未拆除运输螺栓和包装材料。	检查洗衣机的安装是否正确。
	没有调节支撑脚。	检查洗衣机是否水平放置平稳。
	滚筒内衣物摆放不均匀。	暂停运行洗衣机，重新手动将衣物摆放均匀。
	筒内衣物太少。	装入更多衣物。
	地面不平稳，如木质地板。	参阅“洗衣机放置”一节的相关段落。
程序运行时间超过显示时间：	使用了过量的洗涤剂。	减少洗涤剂用量或使用其他洗涤剂。参见第 93 页“洗衣粉使用类型和用量”
	洗衣机放置位置不平。	重新手动摆放好滚筒内的衣物，然后重新开始脱水阶段。参见“洗衣机放置”一节的相关段落。

故障	可能的原因	解决方法
的周期比显示的时间短。	设备根据衣物负载计算新的时间。	
脱水功能启动延迟或洗衣机不脱水：	<p>电子失衡检测装置已断开，因为滚筒内的衣物摆放不均匀。滚筒通过反向旋转重新摆放衣物。</p> <p>这种情况可能会在失衡情况消失前重复出现几次，然后才可以恢复正常脱水。如果 10 分钟后，滚筒内的衣物仍然无法摆放均匀，洗衣机将不会进行脱水。这种情况下，需要手动重新将衣物摆放均匀，然后再选择脱水程序。</p>	暂停运行洗衣机，重新手动将衣物摆放均匀。
洗衣机发出异常噪音：	洗衣机未正确安装。	确保洗衣机水平放置平稳。请参见“安装”一节的相关内容。
	未拆除运输螺栓或包装物	确保拆除包装物和/或运输螺栓。请参见“拆除包装”一节的相关内容。
	衣物量可能过少。	向滚筒内添加更多衣物。
滚筒内看不到水：	洗衣机采用先进技术，非常经济划算，用水极少又不影响洗衣性能。	

### **i** 注意

如果无法确定或解决问题，请与我们的维修服务中心联系。

在致电维修服务中心之前，请记住您的洗衣机的型号、序列号和购买日期：维修服务中心需要这些信息来为您解决问题。

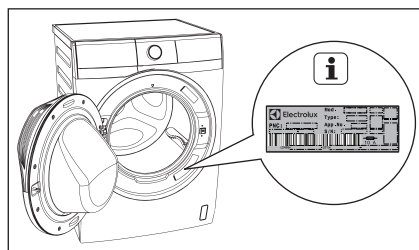

## 9.2 紧急开门

当遇停电情况下或设备门保持锁定状态。电源恢复时，该洗涤程序继续进行。但如果门仍然锁定在断电的情况下，可以使用紧急解锁功能来打开它。

开门之前：



确保水温和洗衣不热。如果必要，等到凉了才开门。

确保洗衣机滚筒内的水位不会太高。进行紧急排水，如有必要（参考第 97 页，“紧急排水”）。

确保洗衣机滚筒不旋转。如果必要，等到洗衣机滚筒停止转动才开门。

开门，步骤如下：

1. 按下“开/关”按钮，使得机器关闭。将电源线从插座中拔出。
2. 如图所示，打开盖门。
3. 向下拉动两次紧急解锁扳柄，然后打开门。
4. 拿出衣物。
5. 重新装上盖门。

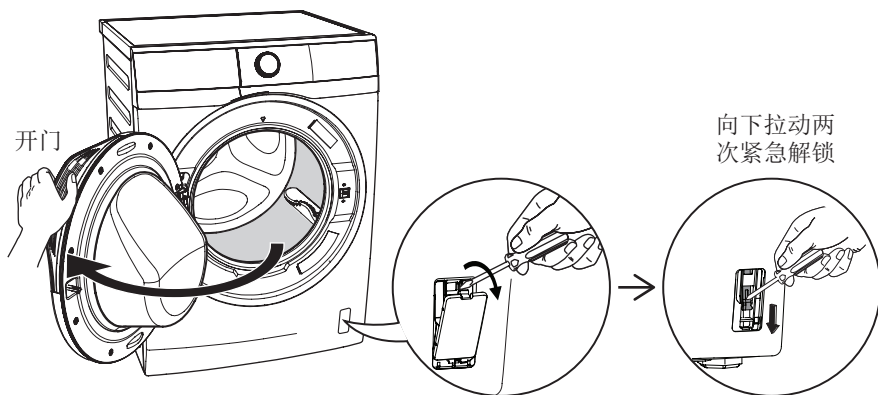

## 10. 技术参数

尺寸（高/宽/深）	EWF7524D3WB / EWF8024D3WB : 848 x 596.5 x 567.5 mm EWF9024D3WB : 848 x 596.5 x 659.0 mm		
电源（电压/频率）	220-240 V~ / 50 Hz		
吸收的总功率	2000 W		
最小熔断保护	10 A		
供水压力（最大/最小）	0.8 MPa / 0.05 MPa		
最大衣物量 (晾衣服)	程序	EWF7524D3WB EWF8024D3WB	EWF9024D3WB
	Off	-	-
	Cottons	Max. <sup>1)</sup>	Max. <sup>1)</sup>
	Mixed	4 kg	4 kg
	Delicates	4 kg	4 kg
	Bedding	3 kg	3 kg
	Energy Saver	Max.	Max.
	Tub Clean	-	-
	Spin	Max.	Max.
	Rinse + Spin	Max.	Max.
	Baby Care	4 kg	4 kg
	Quick 15	1.5 kg	1.5 kg
	Daily 39	4 kg	5 kg
Full Wash 60	Max.	Max.	
Favourite	-	-	
脱水速度（最快/最慢）	1200 rpm / 400 rpm		

1) 最大容量取决于洗衣机的型号（请参阅控制面板上的定义）。

## 11. 安装

### 11.1 拆除包装

 小心:

在使用洗衣机前，必须拆除所有运输螺栓和包装物。建议保留所有的运输装置以备日后再次运输洗衣机时使用。

1. 佩戴手套。剪切和删除 4 切出条带，如图所示。

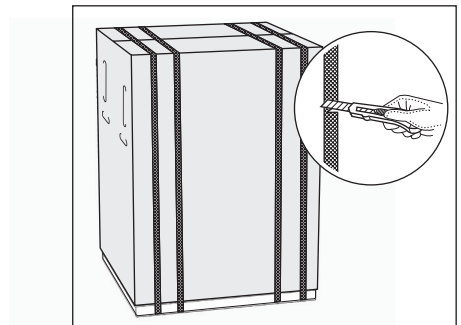

- 取下纸箱盒。取出所有聚苯乙烯泡沫包装材料。撕掉洗衣机外覆的塑料包装袋。

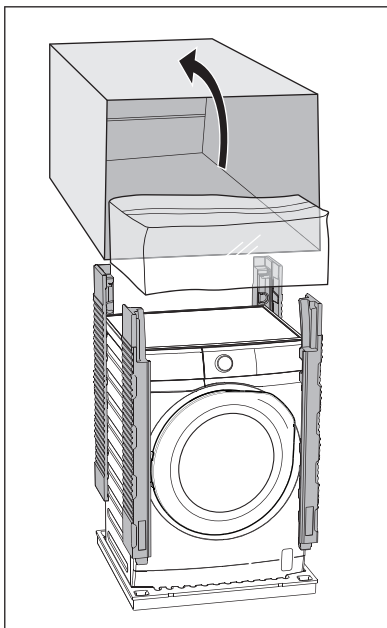

- 打开机门。取出门封处的聚苯乙烯泡沫块以及洗衣滚筒内的所有物品。

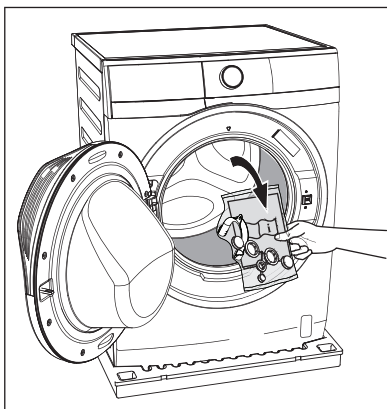

- 将其中一块聚苯乙烯泡沫包装放在洗衣机后面的地面上。小心地将洗衣机背面朝下平放在地面上。确保不要损坏水管。

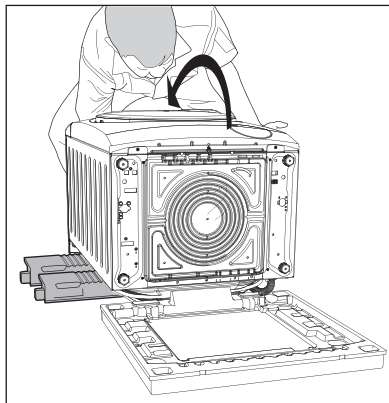

- 拆下聚苯乙烯泡沫底座。

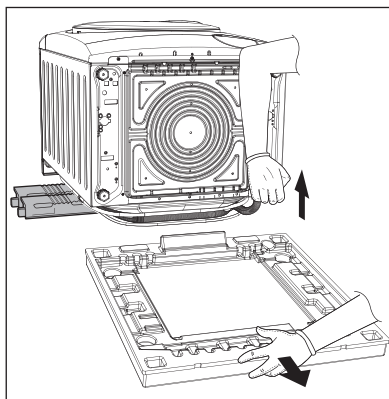

- 垂直向上拉起洗衣机。
- 将电源线以及进水和排水软管从洗衣机背部的管夹 (A) 上取下。

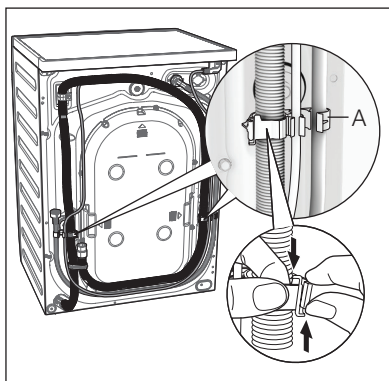

8. 拆下三个运输螺栓。
9. 拔出塑料垫片。

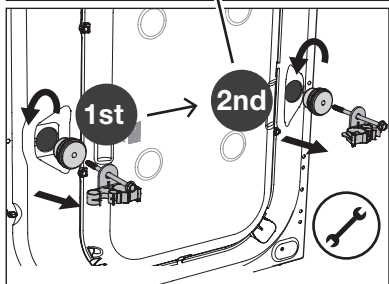
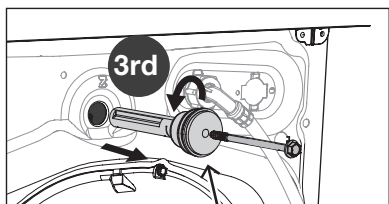

10. 在孔口处盖上塑料盖。您可以在用户手册的包装袋中找到这些塑料盖。

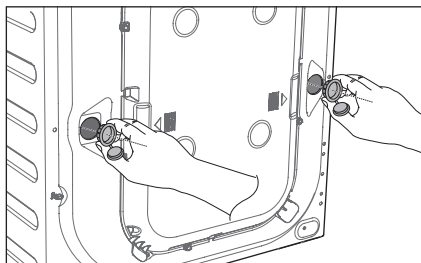
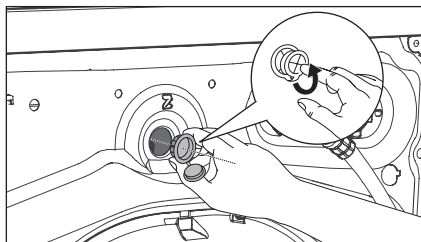
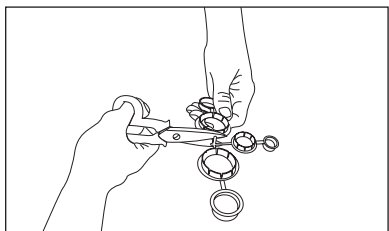

## 11.2 洗衣机放置

为了保证洗衣机能够正常工作，请务必将洗衣机放置于坚实平坦的地面。

不得将洗衣机安装在带锁门、推拉门或合页位置与机门相对从而会限制机门打开的门后。

在洗衣机顶部和侧面放置水平尺，检查水平情况。

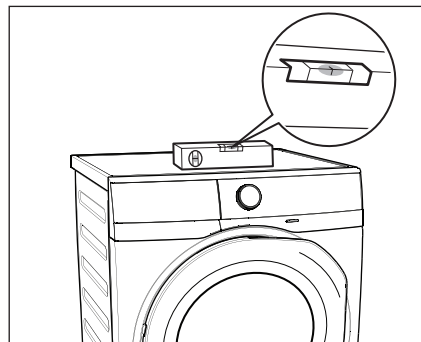

如果没有水平尺，可利用门框边缘、纸板或台面作为参照物，检查洗衣机是否处于水平状态。



可以松动或收紧底脚来调节水平。正确调节洗衣机的水平情况，可防止洗衣机在运行过程中出现振动、噪音和位移。

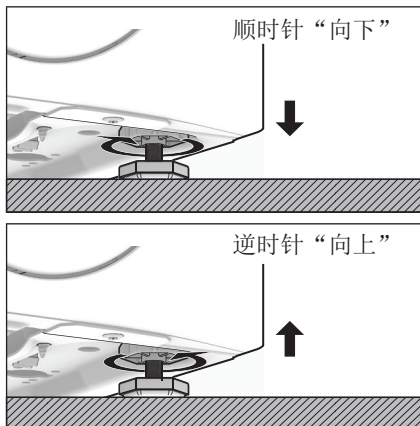

调整好洗衣机的水平之后，尝试从各个边角摇动它。如果洗衣机发生晃动，请再次调整底脚，直到洗衣机保持水平并且不再摇晃为止。

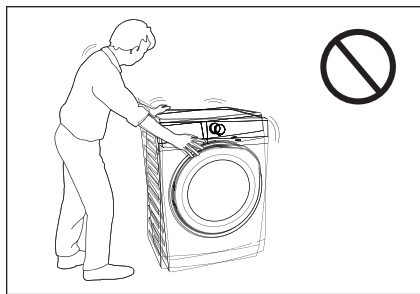

切勿在洗衣机底部放置纸板、木块或类似物品来调节地面的不平整。

将洗衣机放置在平整坚实的地面上。确保地垫、地毯等不会阻碍洗衣机周围的空气流通。

检查并确认洗衣机没有接触墙壁或橱柜。

## 11.3 进水

将进水软管连接到  $3/4$ "BSP 螺纹的水龙头。

请使用洗衣机随附的软管。不要使用旧的软管。

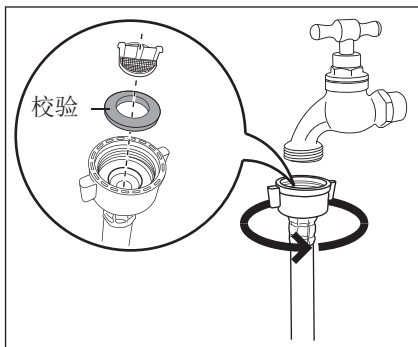

进水软管的另一端连接到洗衣机，可任意方向自由转动。

松开接头配件，转动软管，再重新紧固接头配件，确保不会漏水。

进水软管不可延长。如果软管太短而不想移动水龙头，可另外购买一根洗衣机进水专用的加长软管。

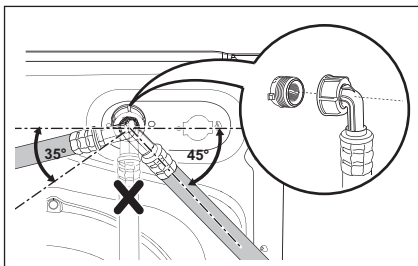

## 11.4 排水

排水软管的末端可采用三种方式放置：

- 使用随机附带的塑料软管导向套吊装在洗手池边缘上方。

### 安装排水导管



采用这种方式时，请确保出水端不会在洗衣机排水过程中脱落。要做到这一点，可将排水软管系在水龙头上或固定在墙上。

- 连接到洗手池的排水管道分支。此分支必须位于存水弯上方，从而使排水软管的弯曲部分至少高于地面 60 cm。

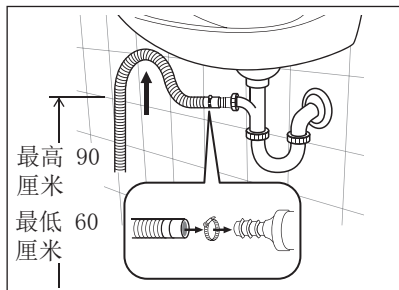

将排水管推到水龙头，并用夹子固定，确保在排水管中形成一个回路，以防水槽中的废弃物进入装置。

- 直接与排水管道相连，高度应在 60 cm 至 90 cm 之间。

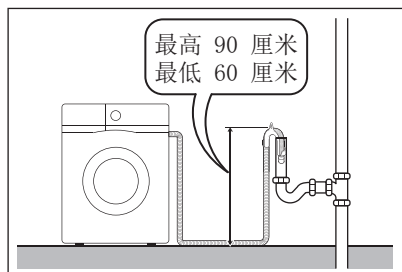

排水软管出水端必须保持畅通，即排水管道的内径必须大于排水软管的外径。

排水软管不得扭结。请将排水软管沿地面放置，只有接近排水口的部分必须提高。

为使洗衣机能够正常工作，排水软管必须卡在机背上部的适当管托上。

## 11.5 电气连接

本洗衣机设计使用 220-240 V 单相 50 Hz 电源。

 连接电源之前，请检查额定标签上提及的额定电源条件。

“使用不正确的电源可能会使保修失效。”

请检查并确保您的家庭用电设施可以承受需要的最大负载（2.0 kW），同时要考虑正在使用的任何其他电器。

 **小心！** 洗衣机必须连接至接地插座。

对于因不遵守上述安全预防措施而造成的洗衣机损坏或人员伤害，制造商概不负责。

 电源线的更换应由我们的维修服务中心完成。

安装洗衣机时，必须确保能够轻松连接电源线。

## 12. 关注环保

### 12.1 包装材料



标有  符号的材料可以循环利用。

>PE<=polyethylene  
>PS<=polystyrene  
>PP<=polypropylene

这表示此类材料如果正确放入适当回收容器内处理，可以循环利用。

### 12.2 废旧洗衣机

选择经过授权的废物处理点处置您的废旧电器。请为保持环境整洁贡献您的力量！

产品或产品包装上标记的  符号表示此产品不可作为生活垃圾处理。

而是应送至适当的收集点，作为电气电子设备进行回收利用。

确保正确处置本产品将有助于防止因本产品的不当废物处理而可能对环境 and 人体健康造成的负面影响。

有关回收利用本产品的更多详细信息，请联系您当地的市政办公机构、生活垃圾处理服务站或您购买产品的商店。

### 12.3 环保提示

为了节水节能和保护环境，我们建议您遵循下列提示：

- 为了节省洗涤剂、用水和洗衣时间（也可以保护环境），脏污程度一般的衣物可以不进行预洗。
- 洗衣机满载衣物运行时会更加经济。
- 对衣物进行适当预处理可去除污渍和轻微的脏污，从而可以选择较低温度洗涤衣物。
- 根据水质硬度、衣物脏污程度和衣物量取用适量的洗涤剂。

www.electrolux.com



G0032399-003-A20691810